

 **Descripción/** Tobogán

- Materiales/**
- Estructura de polietileno de alta densidad, libre de mantenimiento y antigraffiti.
 - Pista de acero inoxidable.

 **Description/** Slide

- Materials/**
- Maintenance-free, anti-graffiti, HDPE structure.
 - Stainless steel slide ramp.

 **Description/** Toboggan.

- Matériaux/**
- Structure en polyéthylène haute densité, sans entretien et antigraffiti.
 - Glissière en acier inoxydable.

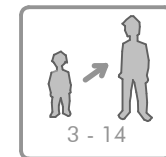
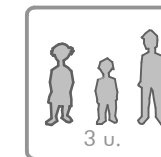
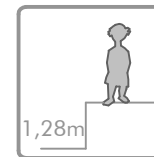

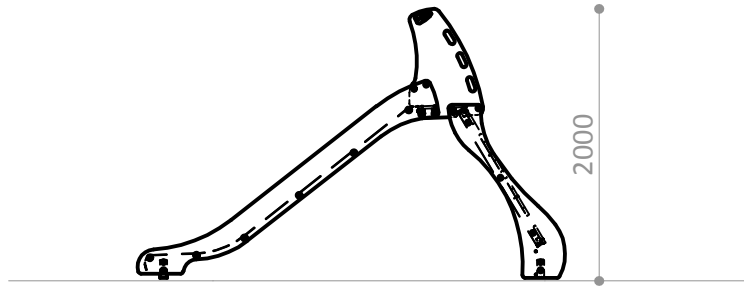

ESPACIO DE SEGURIDAD / ALTURA DE CAÍDA A LIBRE
SAFETY AREA / FREE HEIGHT OF FALL
ZONE DE SÉCURITÉ / HAUTEUR DE CHUTE LIBRE

17,5 m² / 1,28 m

Superficie según EN-1176-1
Surface according to EN-1176-1
Revêtement conforme à la Norme EN-1176-1

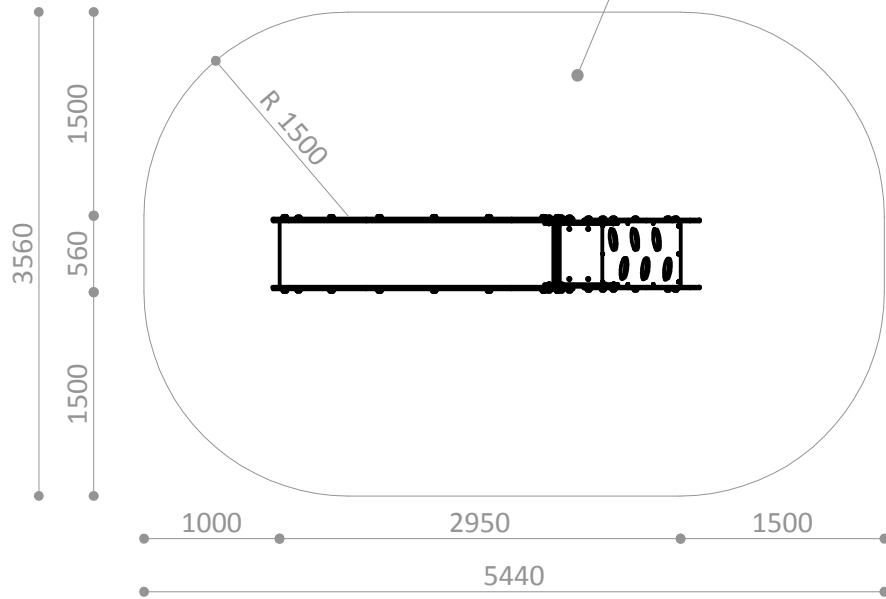

R4826E-01 PISTA

Pieza más grande

Biggest part

La plus grande pièce

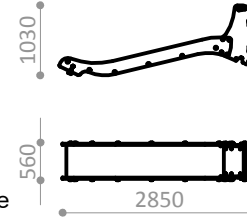

R4826E-01 PISTA

Pieza más pesada

Heaviest part

La pièce la plus lourde

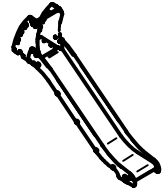

60 Kg.

R4826A

Suelo de hormigón

Concrete ground

Fixation sur béton

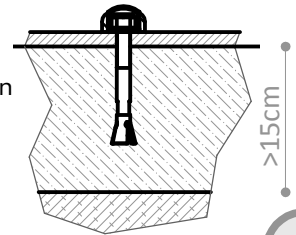

x4

R4826E

Otros suelos

Other grounds

Autres sols

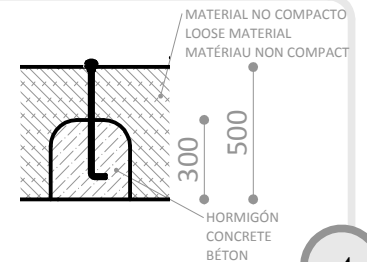

x4

Disponibilidad de repuestos durante 10 años.
Spare parts available for 10 years.
Disponibilité de pièces de rechange pendant 10 ans.

Industrias Agapito se reserva el derecho a modificar sin previo aviso los elementos descritos en este documento.
Industrias Agapito reserves the right to change the items described in this document without prior notice.
Industrias Agapito se réserve le droit de modifier à tout moment et sans préavis les éléments décrits dans le présent document.

