

8102

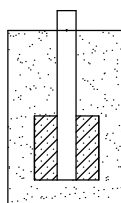

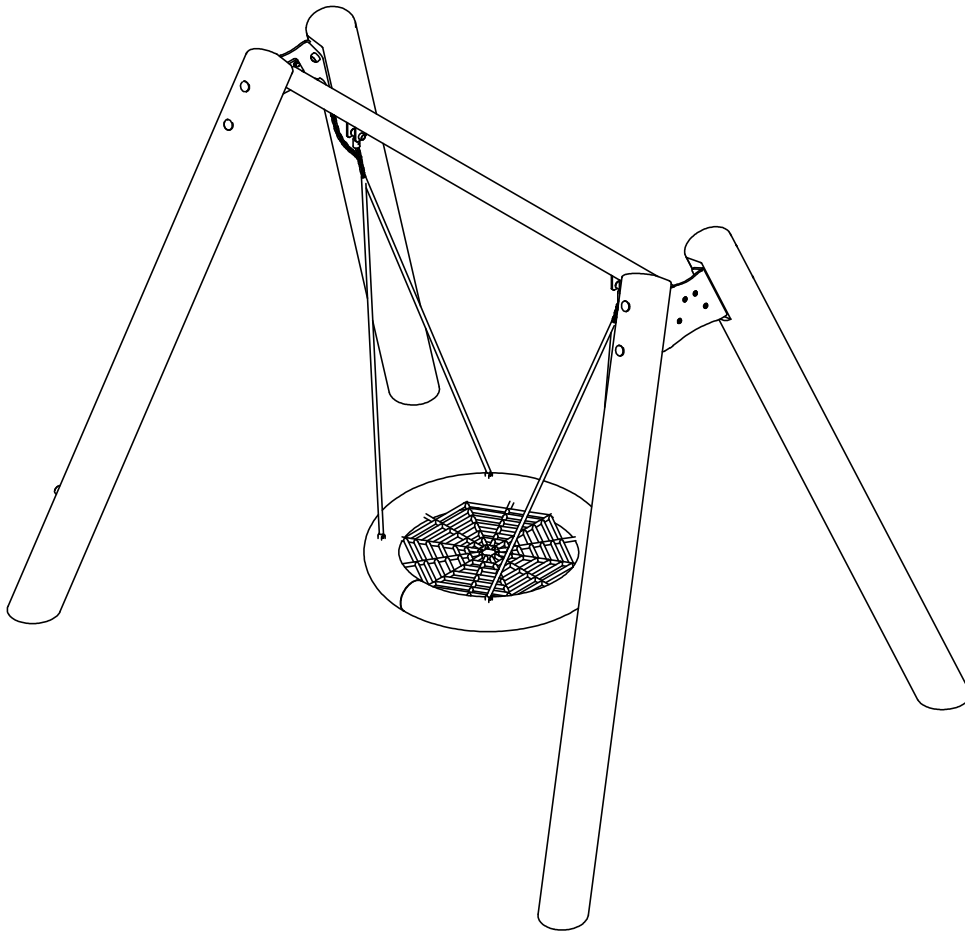

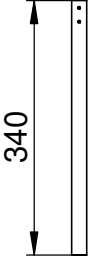

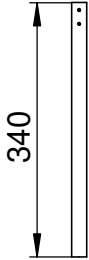
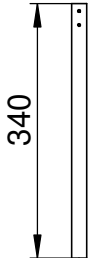
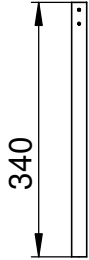
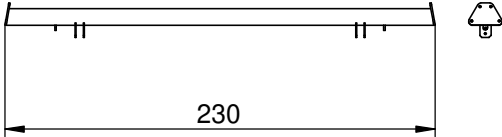
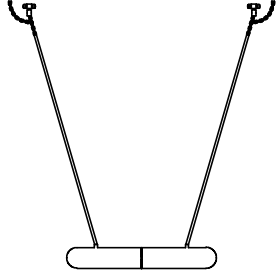
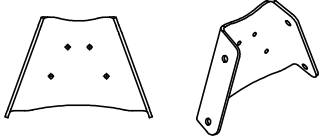
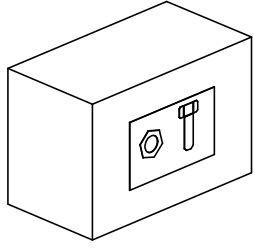

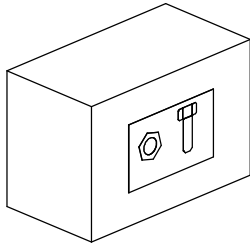



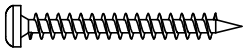



8102N

NR	ELEMENT	8102N
E1		1
E2		1
E3		1
E4		1
E5		1
E6		1

NR	ELEMENT	8102N
E7		2
E8		1

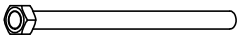

8102N

Nr	Element			$\Sigma$
1		-	S6x60	2
2		-	W6x60	1
3		-	K2_d30_B	12
4		DIN 125	10x20	16
6		-	Z2_d30_B	12
21		DIN 125	8x16	1
56		ISO 7380	M10x30	8
57		DIN 1587	M10	8
58		-	LOCTITE	1
63		DIN 125	12x24	16
74		DIN 985	M12 (OC)	8
77		-	K3_d30_A89_G	1
213		-	Z_NA_1	1
214		-	Z_NA_2	1
229		-	Z_R_42	8
235		-	S3_8100_0	8

8102N

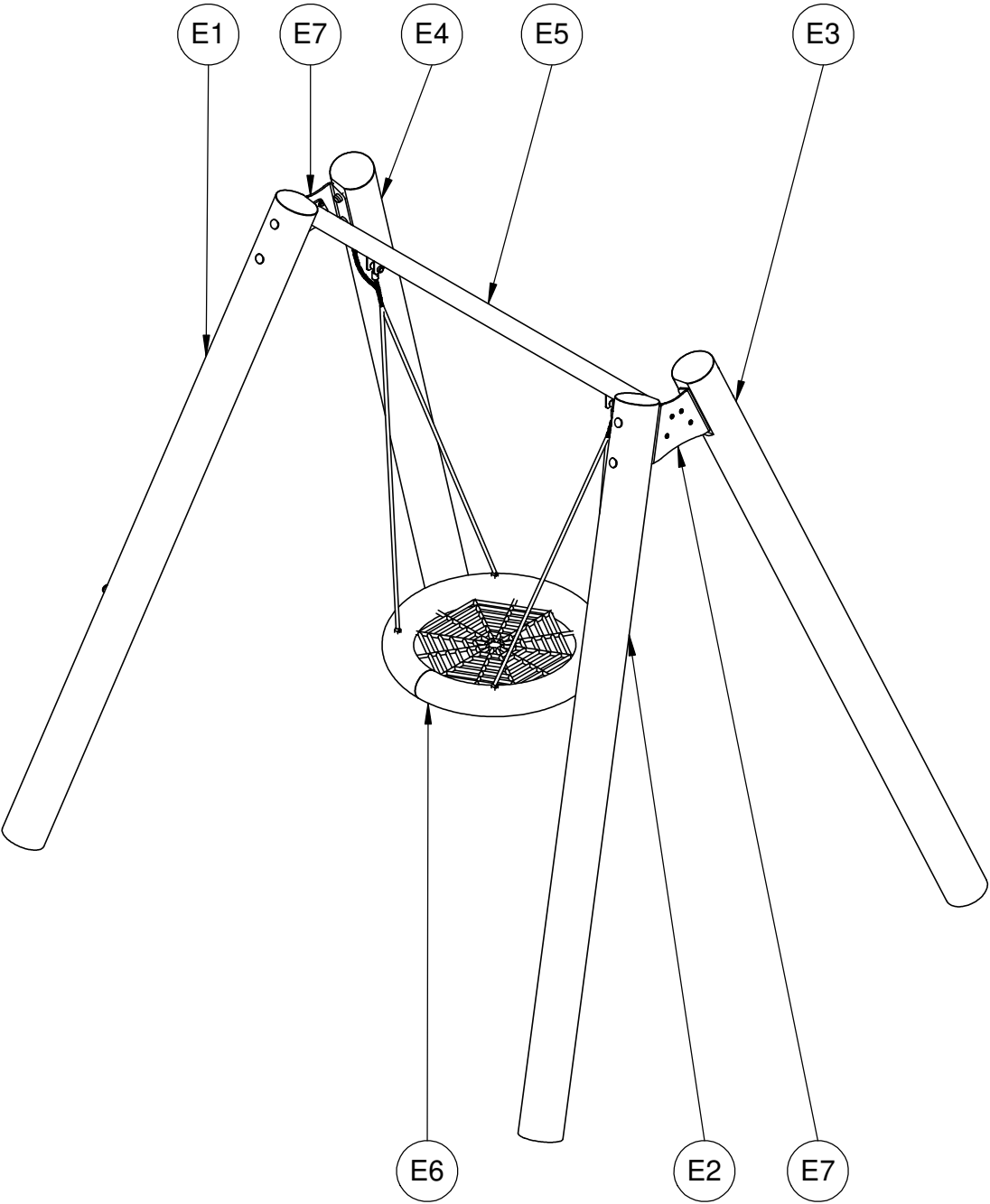

# 8102N

ENG: „Due to the irregular shapes of natural robinia wood trunks, all dimensions provided in the documentation may slightly vary from the actual dimensions of the product.”

PL: “Z uwagi na nieregularne kształty naturalnych pni drewna robinii, wszystkie wymiary podane w dokumentacji mogą nieznacznie odbiegać od rzeczywistych wymiarów produktu.”

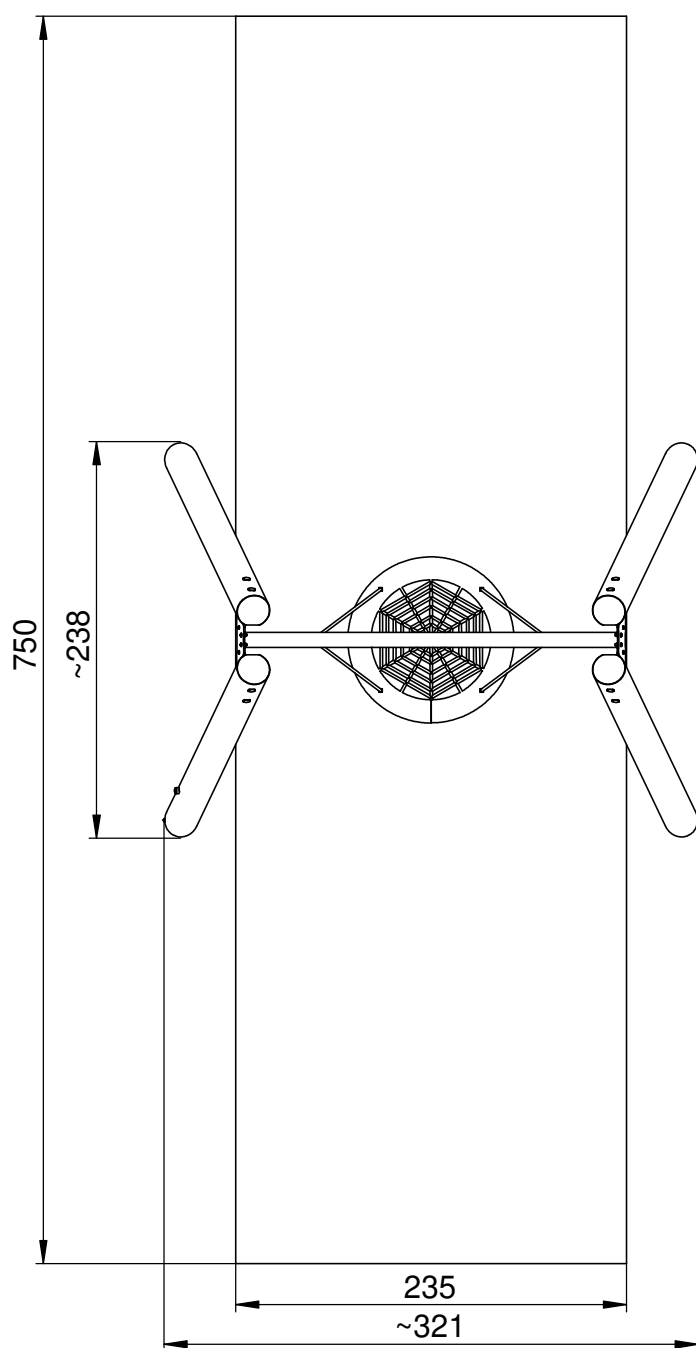
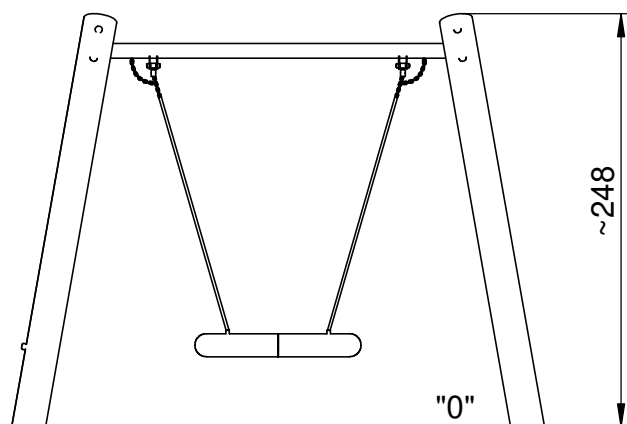

1

8102N

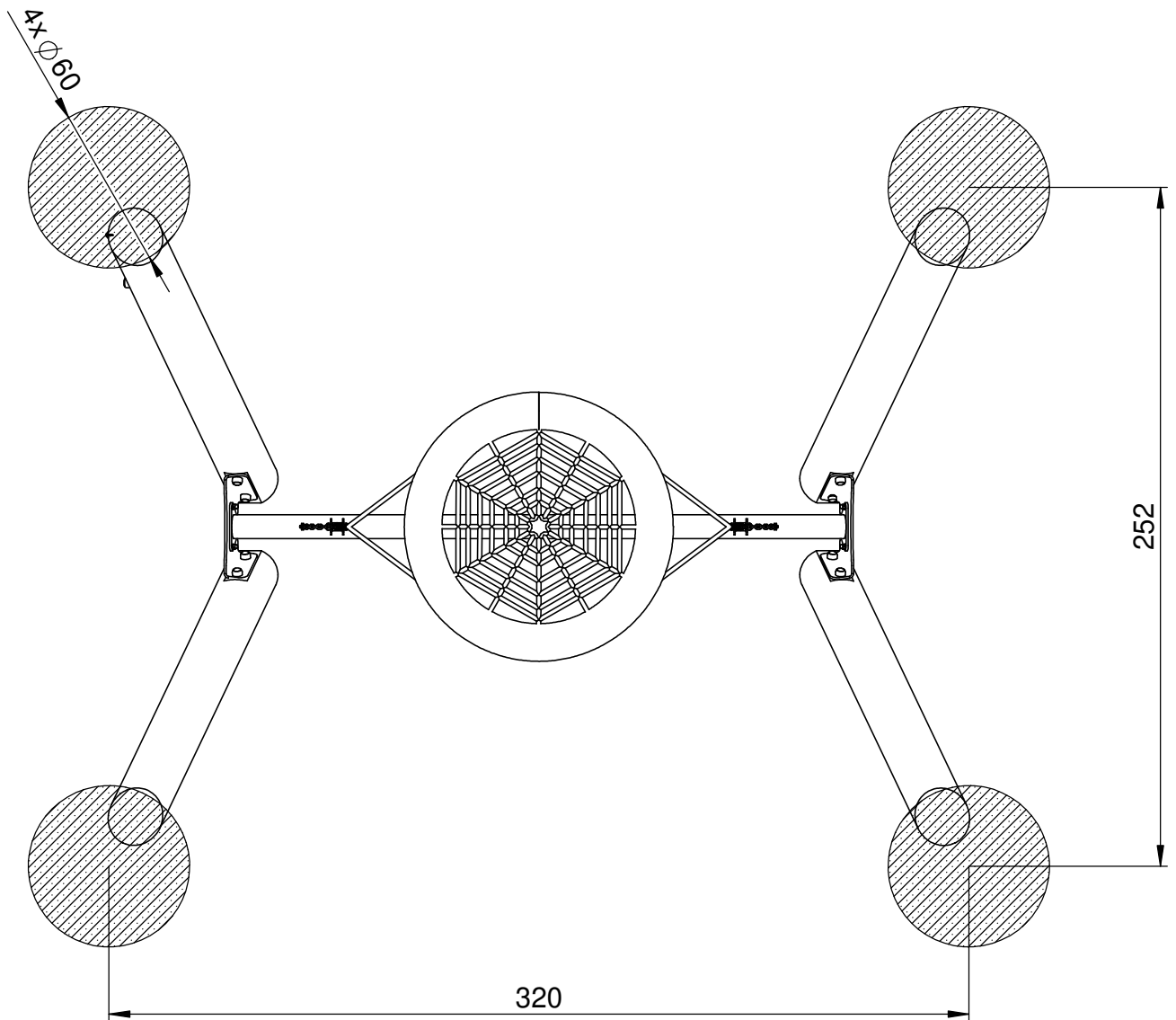
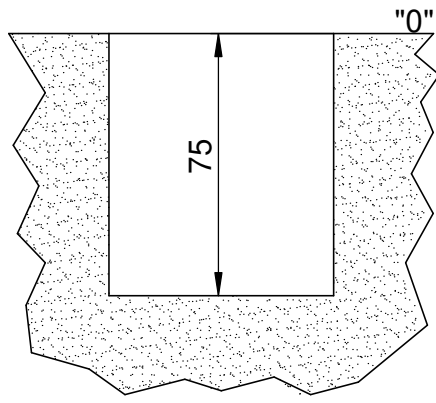

2

8102 N

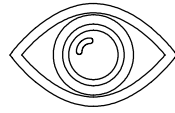

INST\_81\_18\_1

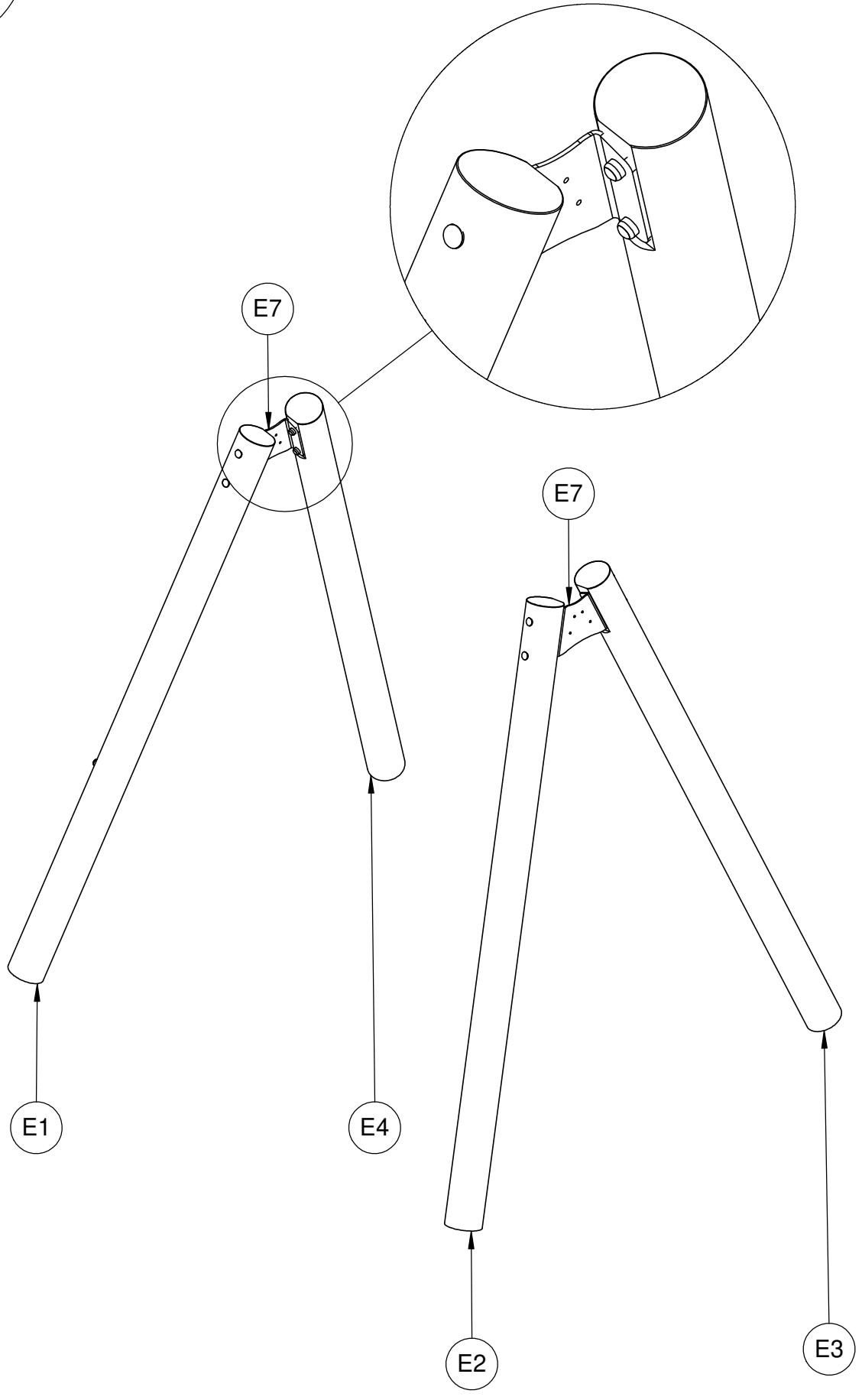



3

8102 N

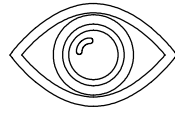

INST\_81\_18\_2

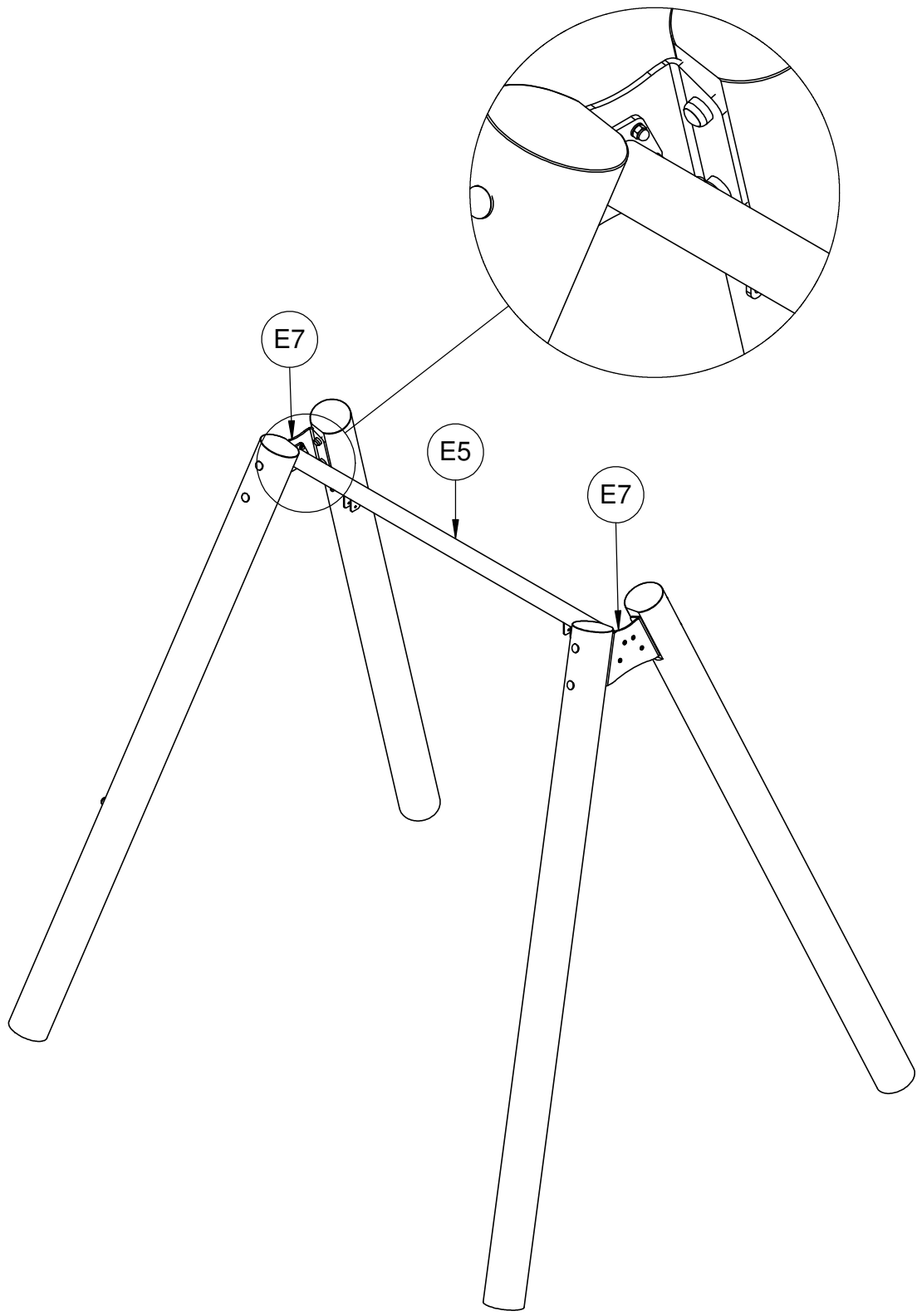

4

8102 N

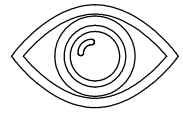

INST\_81\_18\_3

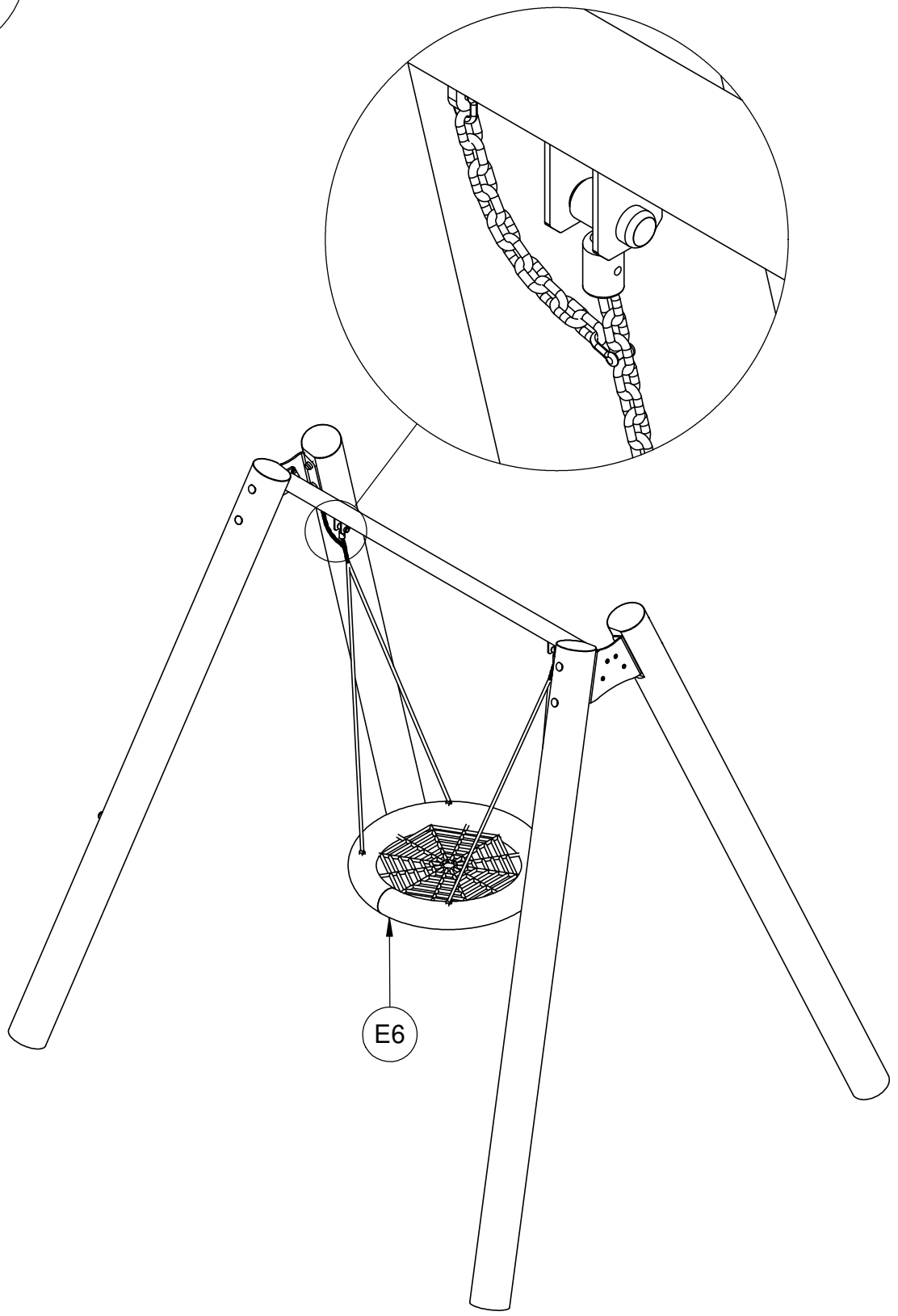

E6

5

8102N

B25 0,4m<sup>3</sup>

min. 48H

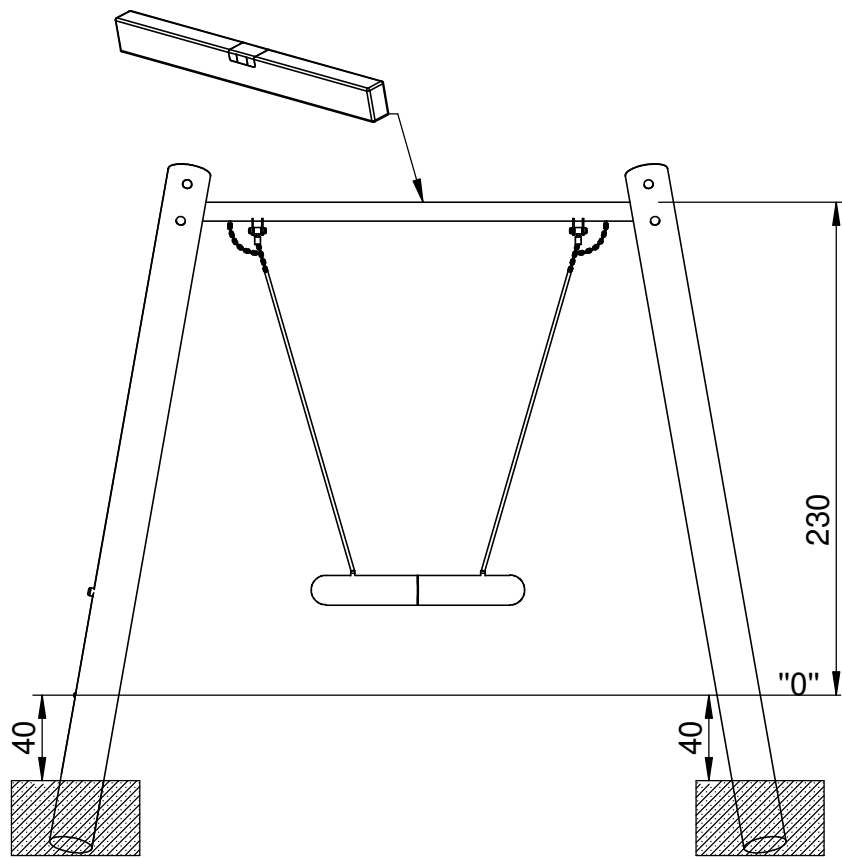
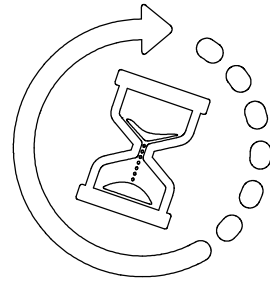
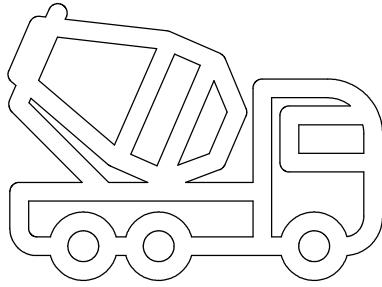

6

8102 N

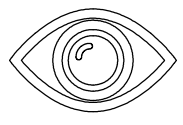
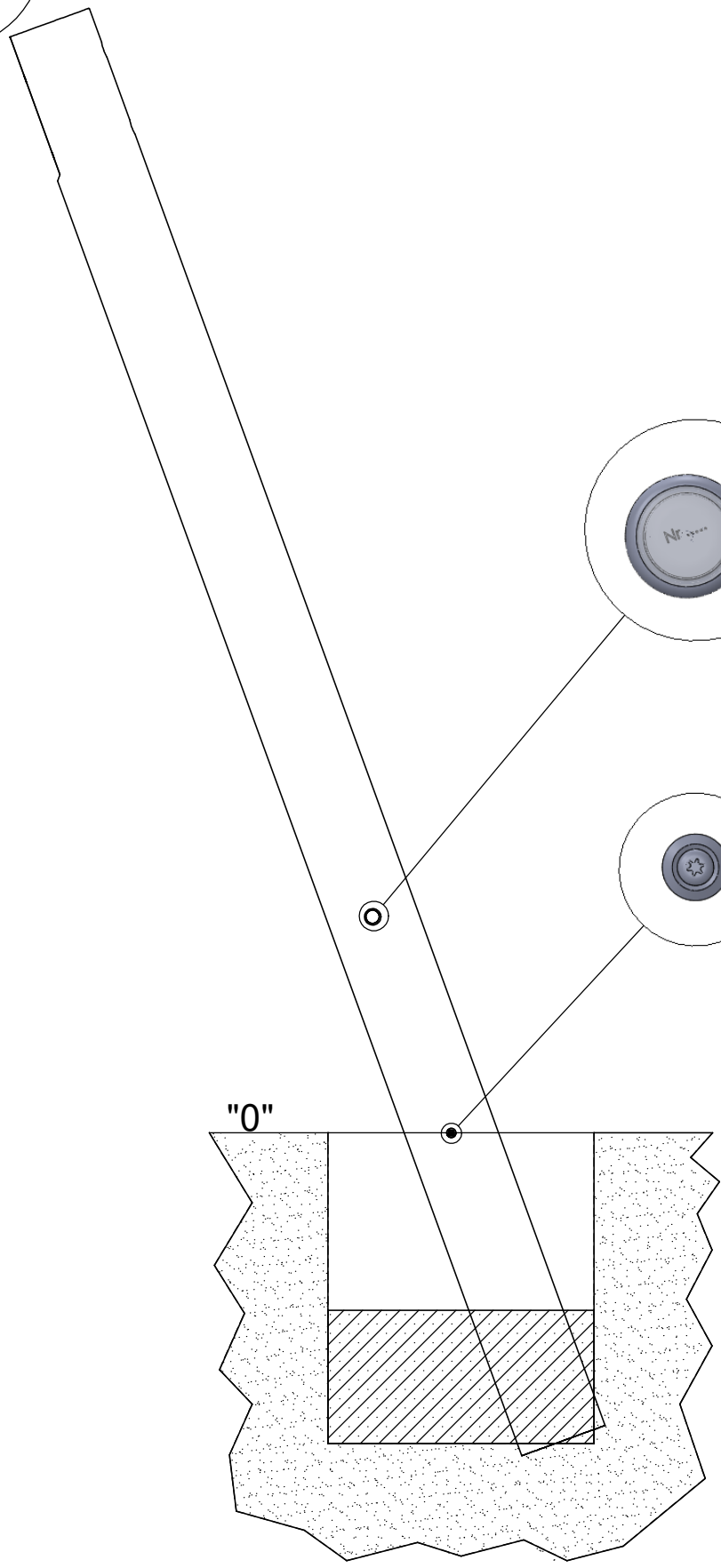

INST\_Z\_5

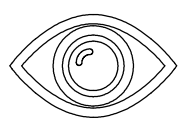
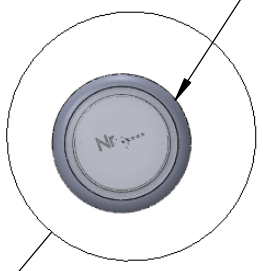

INST\_81\_0\_16

