

9106

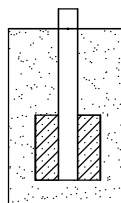
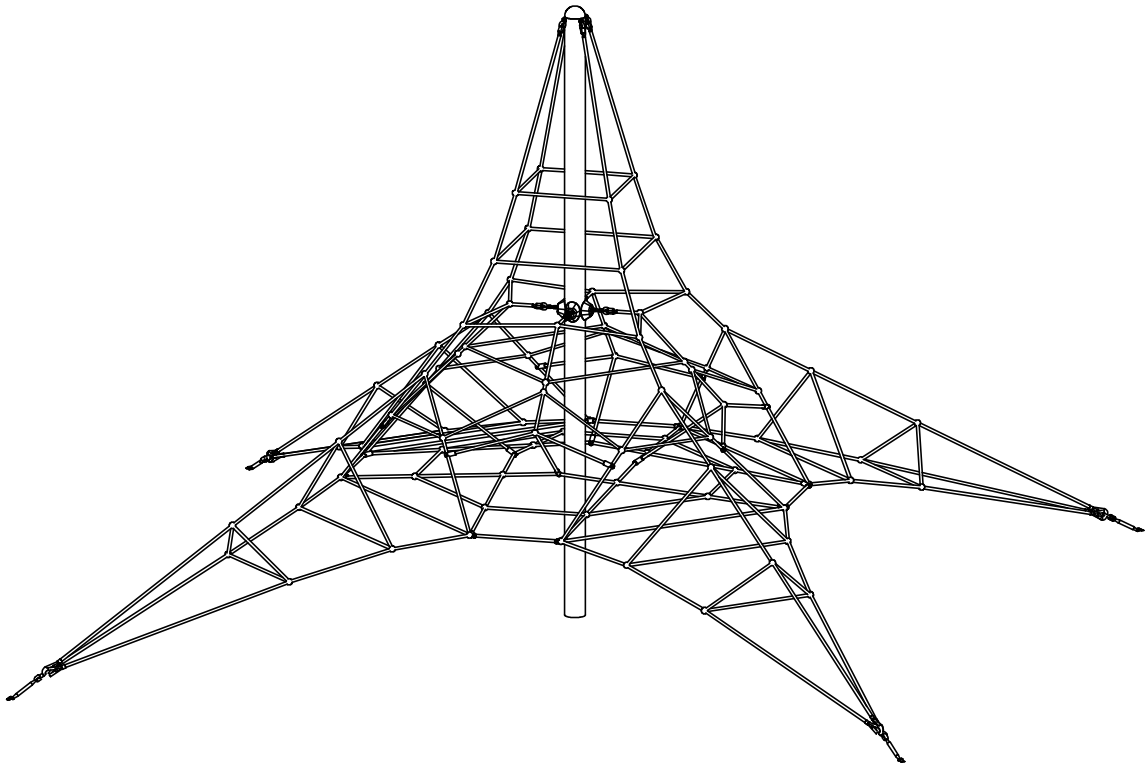

9106 N

**NR**

**ELEMENT**

9106 N

**E1**

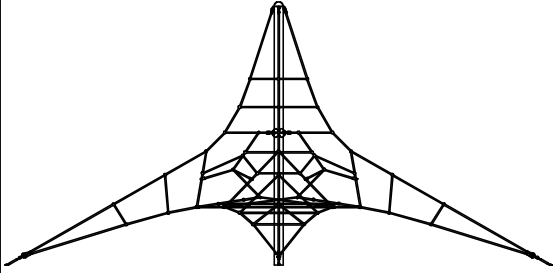

**1**

**E2**

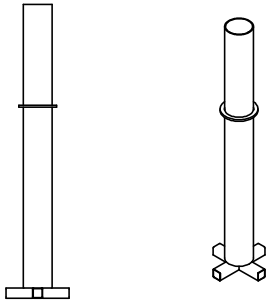

**1**



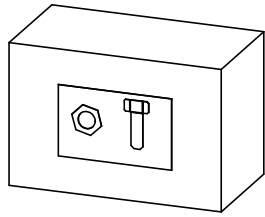



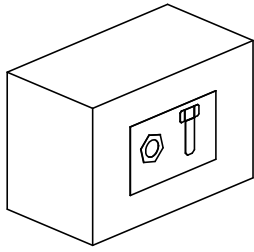

**E3**

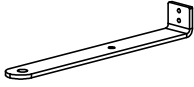
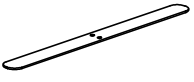

**1**



9106 N

Nr	Element			$\Sigma$
213		-	Z_NA_1	1
214		-	Z_NA_2	1
-		-	9100_1_g8 _G_v1	4
-		-	9100_2_g3 _v1	4
-		-	M12x300	4
159		DIN 934	M12	8
240		DIN 933	M8x25	8
21		DIN 125	8x16	8
187		DIN 934	M8	8

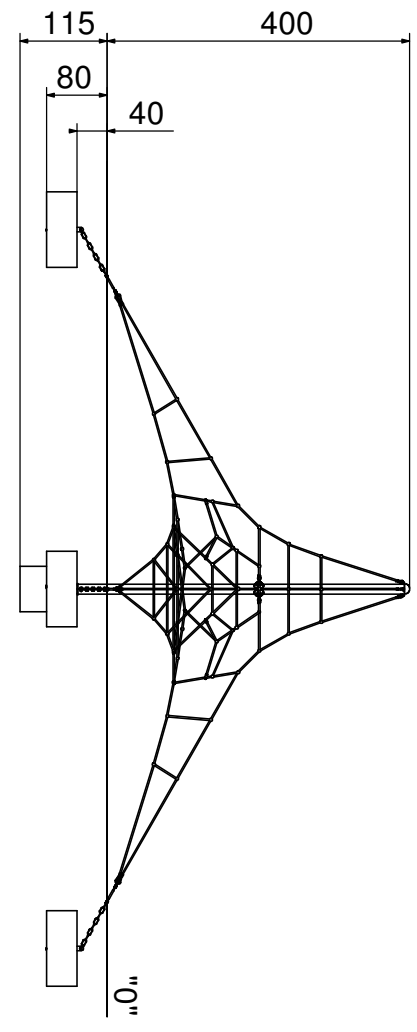
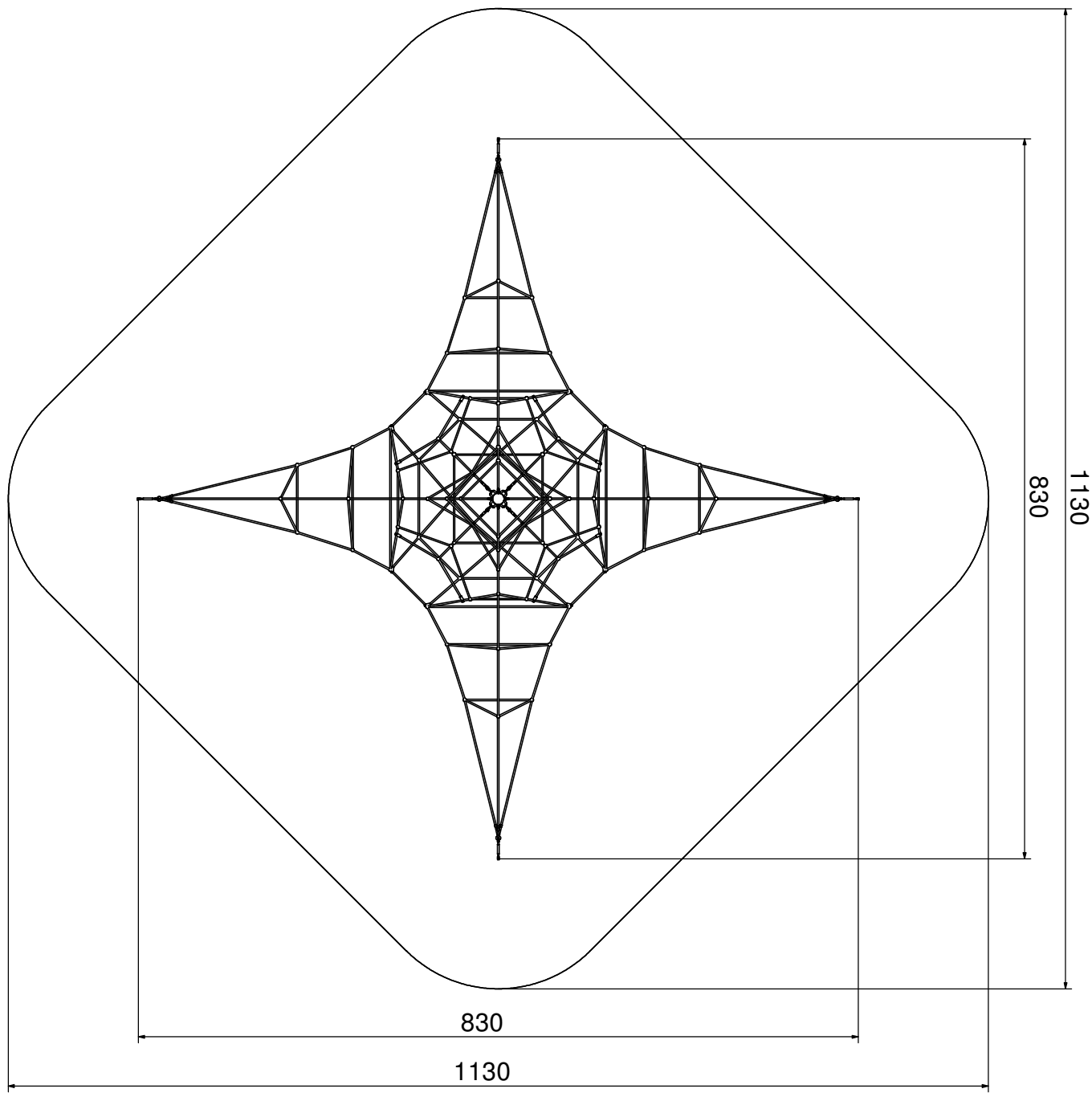

1.

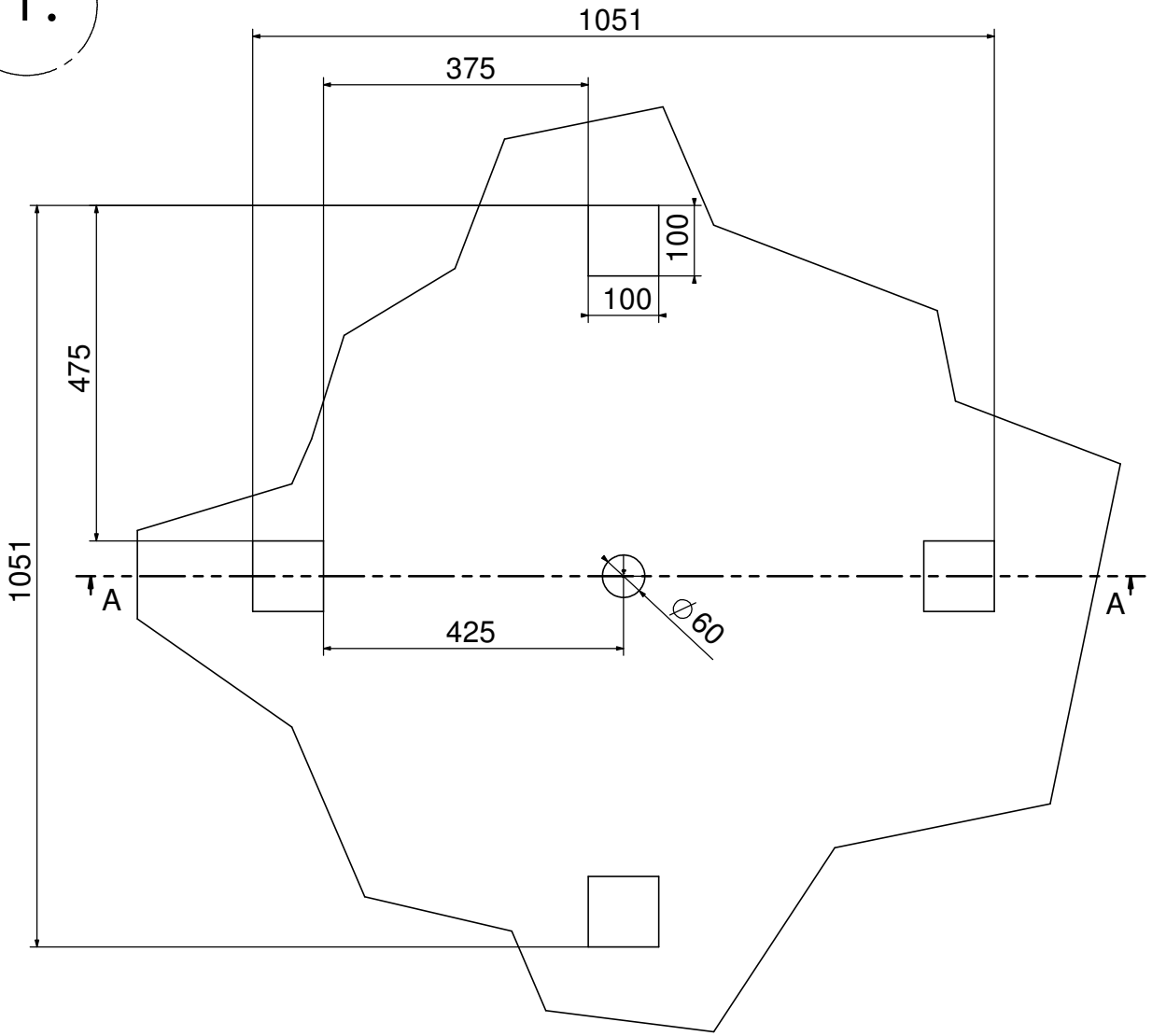

A-A

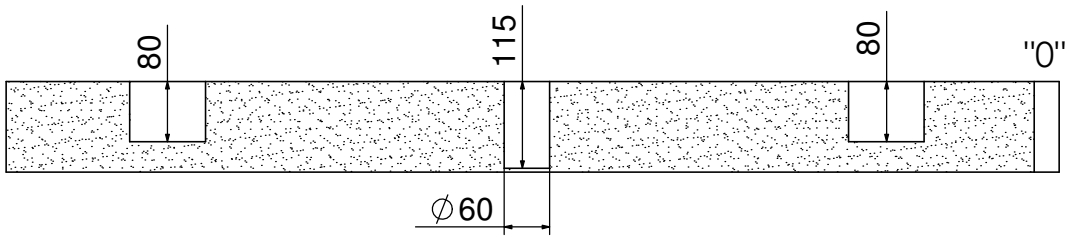

2.

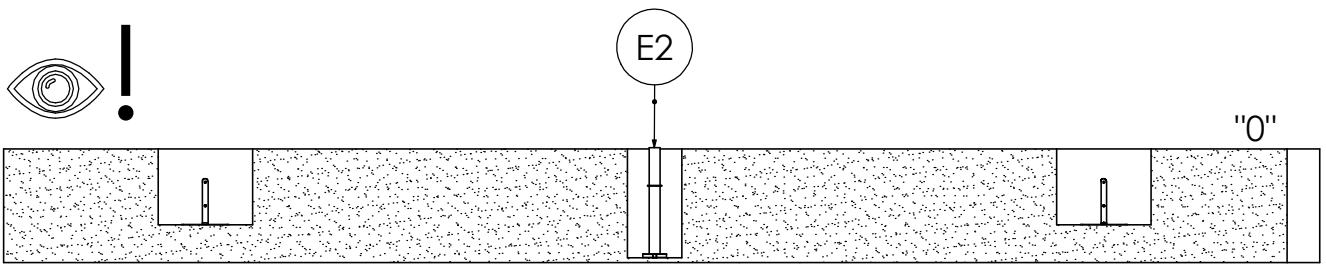
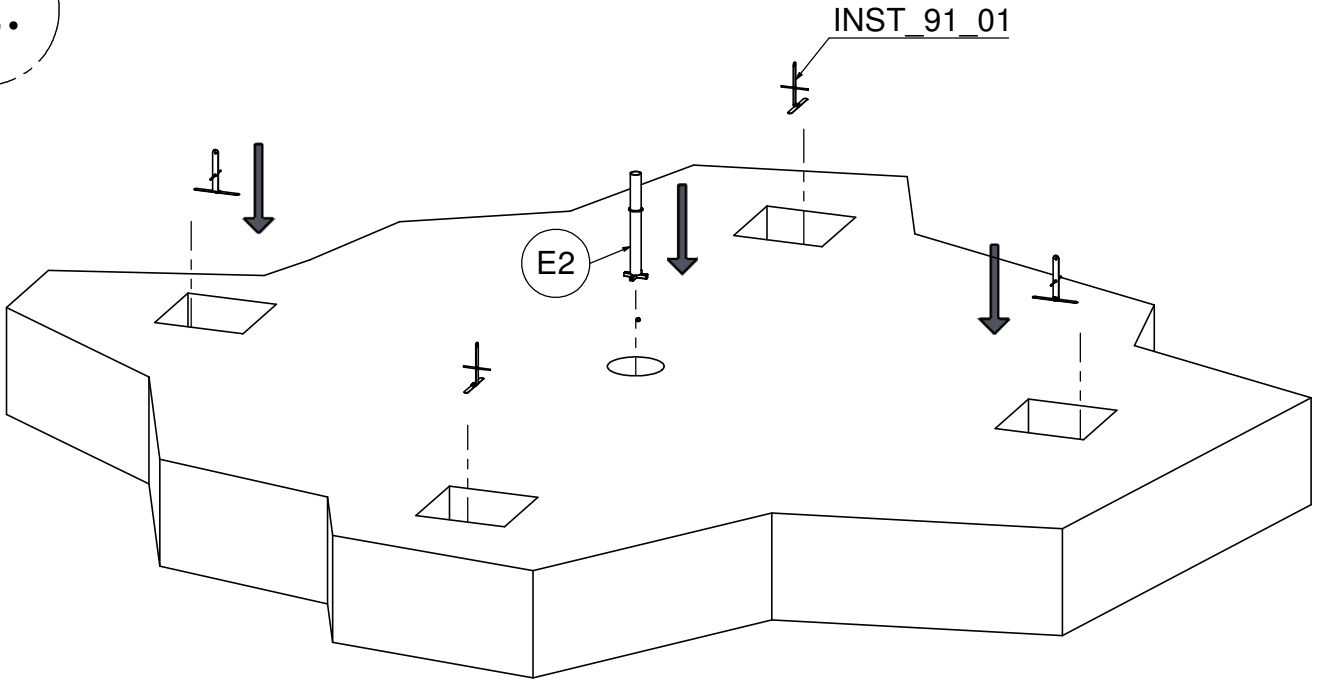

B-B

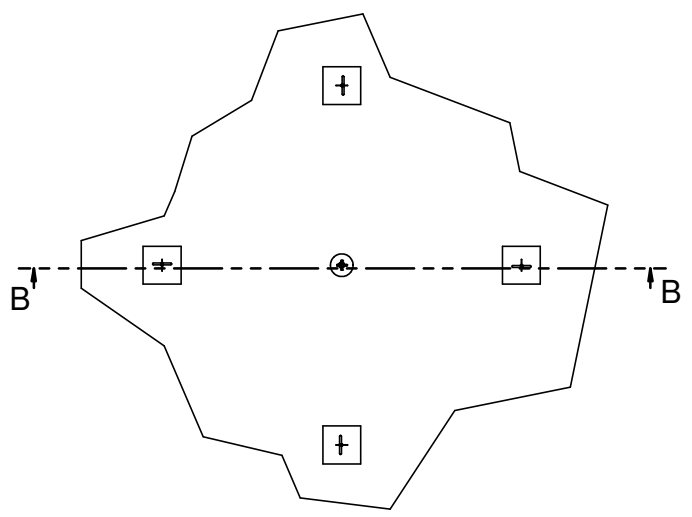

3.

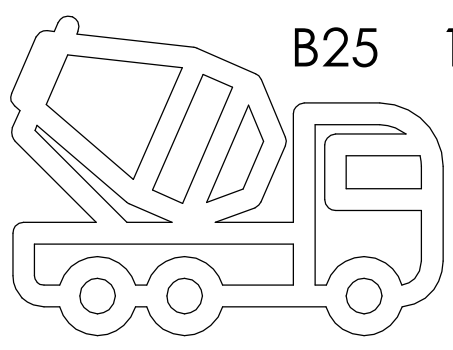

B25 1,9m<sup>3</sup>

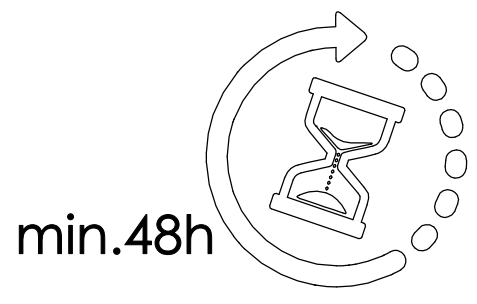

min.48h

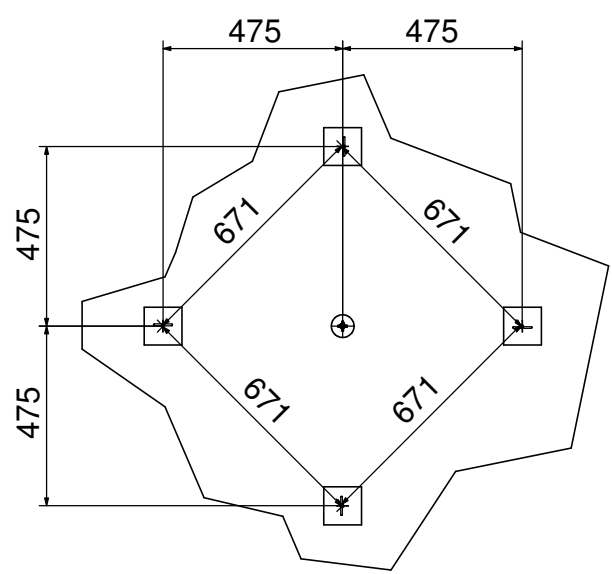
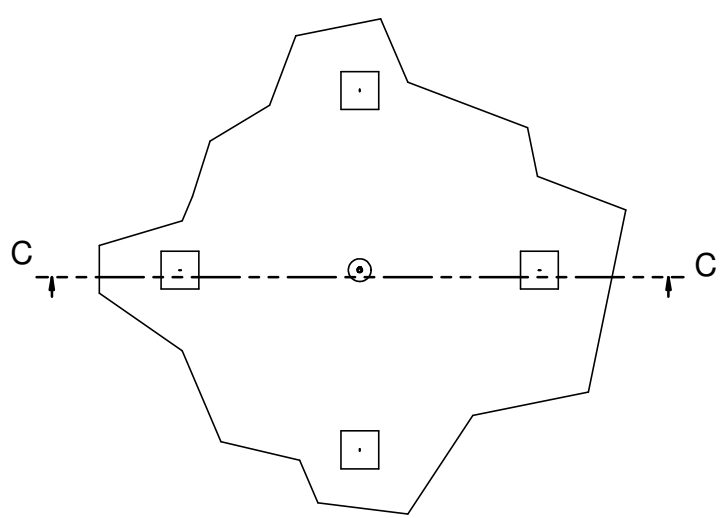

C-C

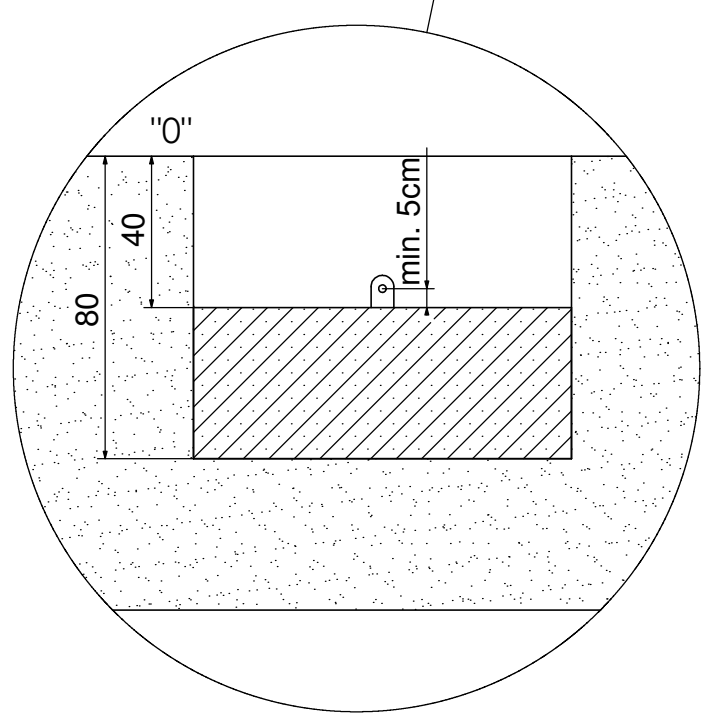
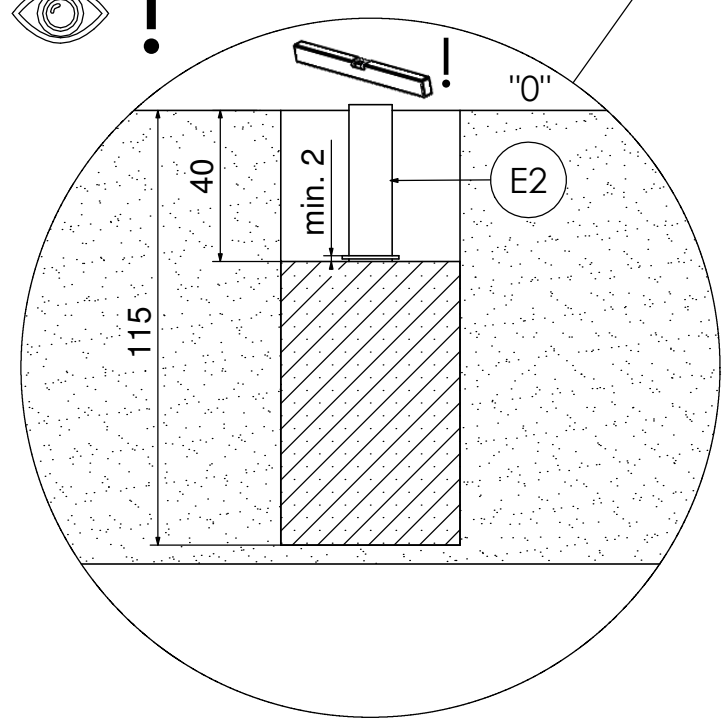
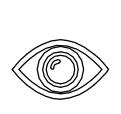
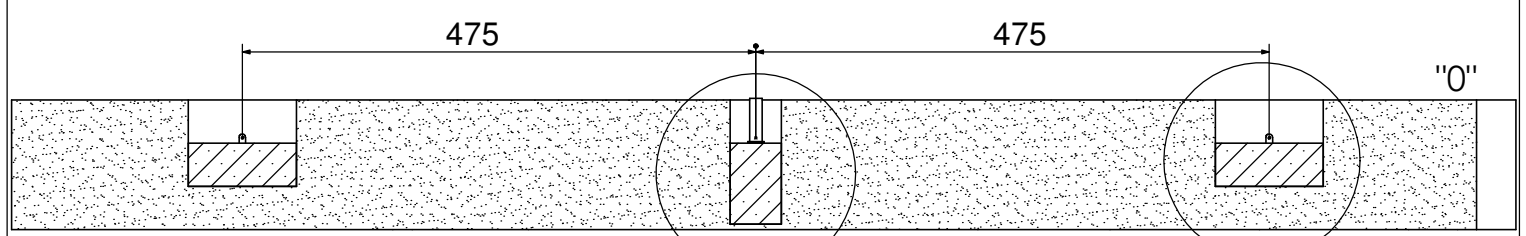

5.

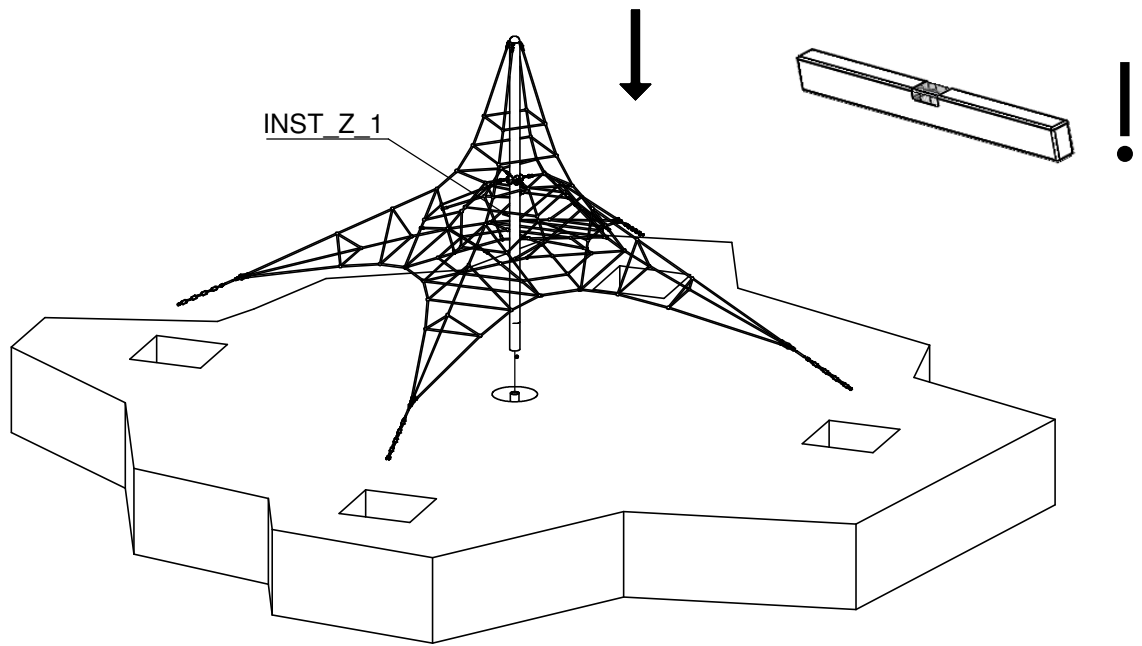



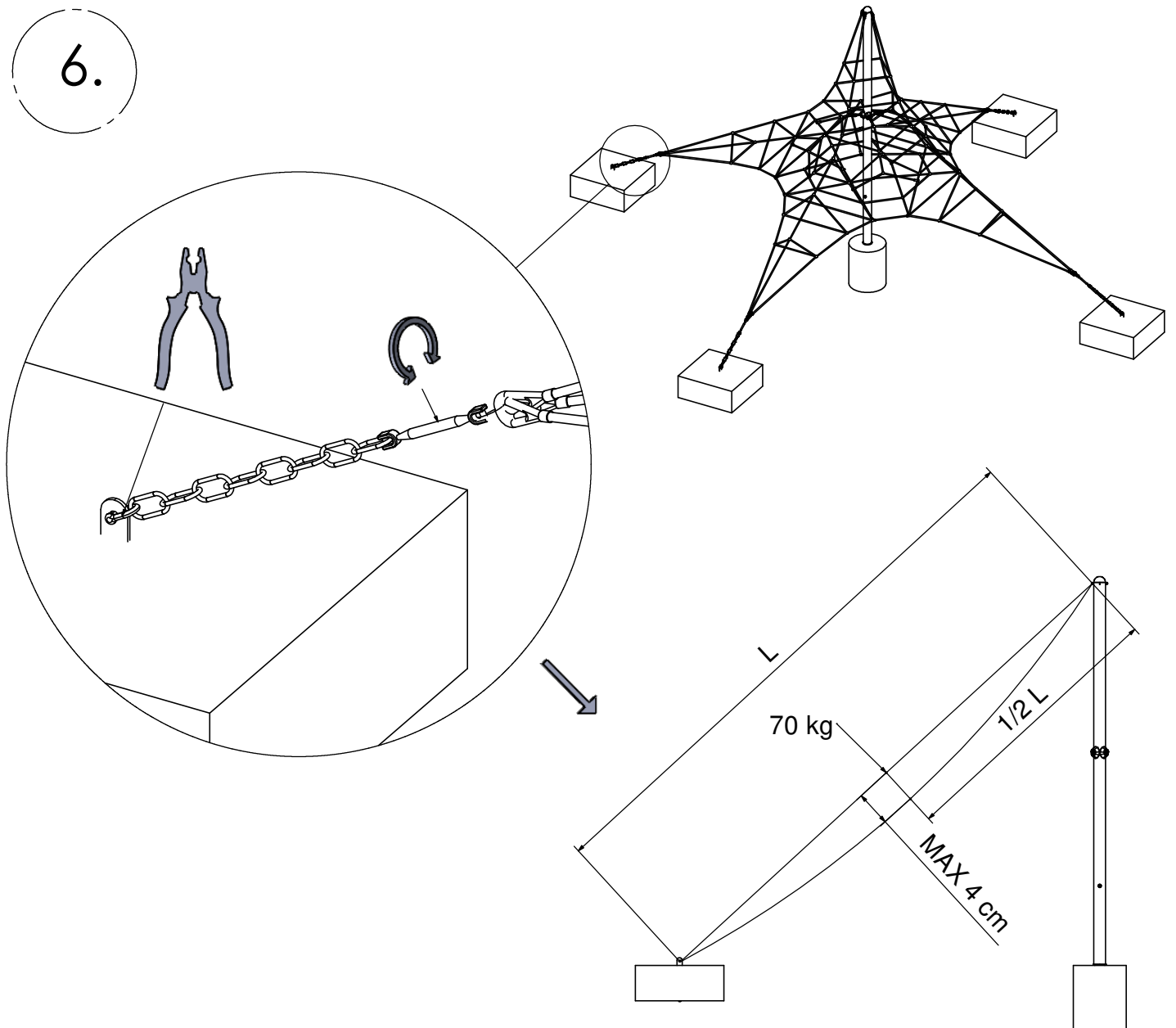



6.





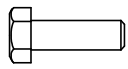

# INST\_91\_01

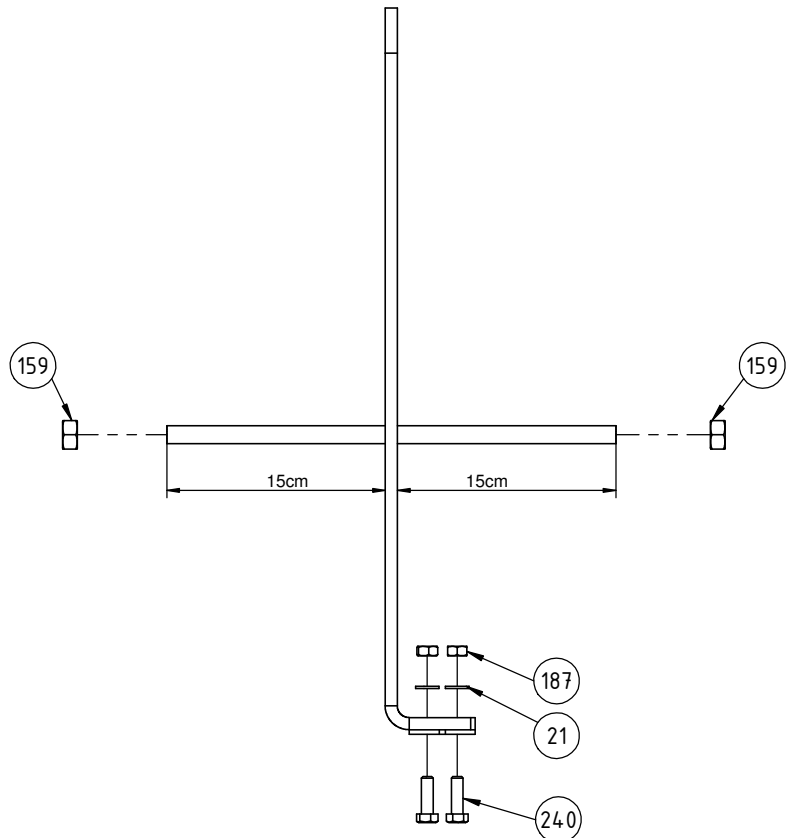
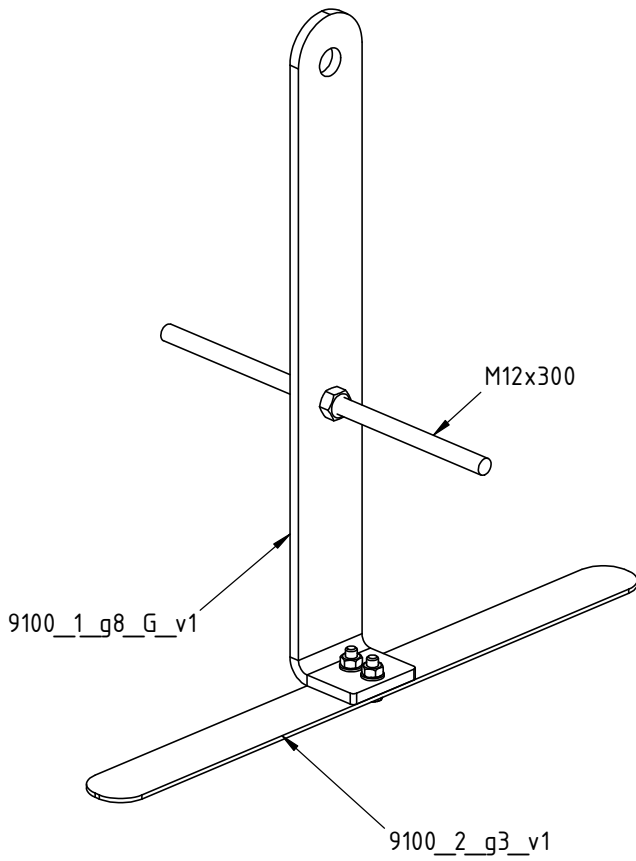
Nr	Σ	Element	DIN	ELEMENT
-	1		-	9100_1_g8_G_v1
-	1		-	9100_2_g3_v1
-	1		-	M12x300
21	2		DIN 125	8x16
159	2		DIN 934	M12
187	2		DIN 934	M8
240	2		DIN 933	M8x25



# INST\_Z\_1

Nr	$\Sigma$	Element		
213	1		-	Z_NA_1
214	1		-	Z_NA_2

