

9075

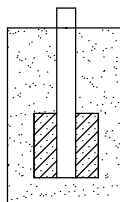
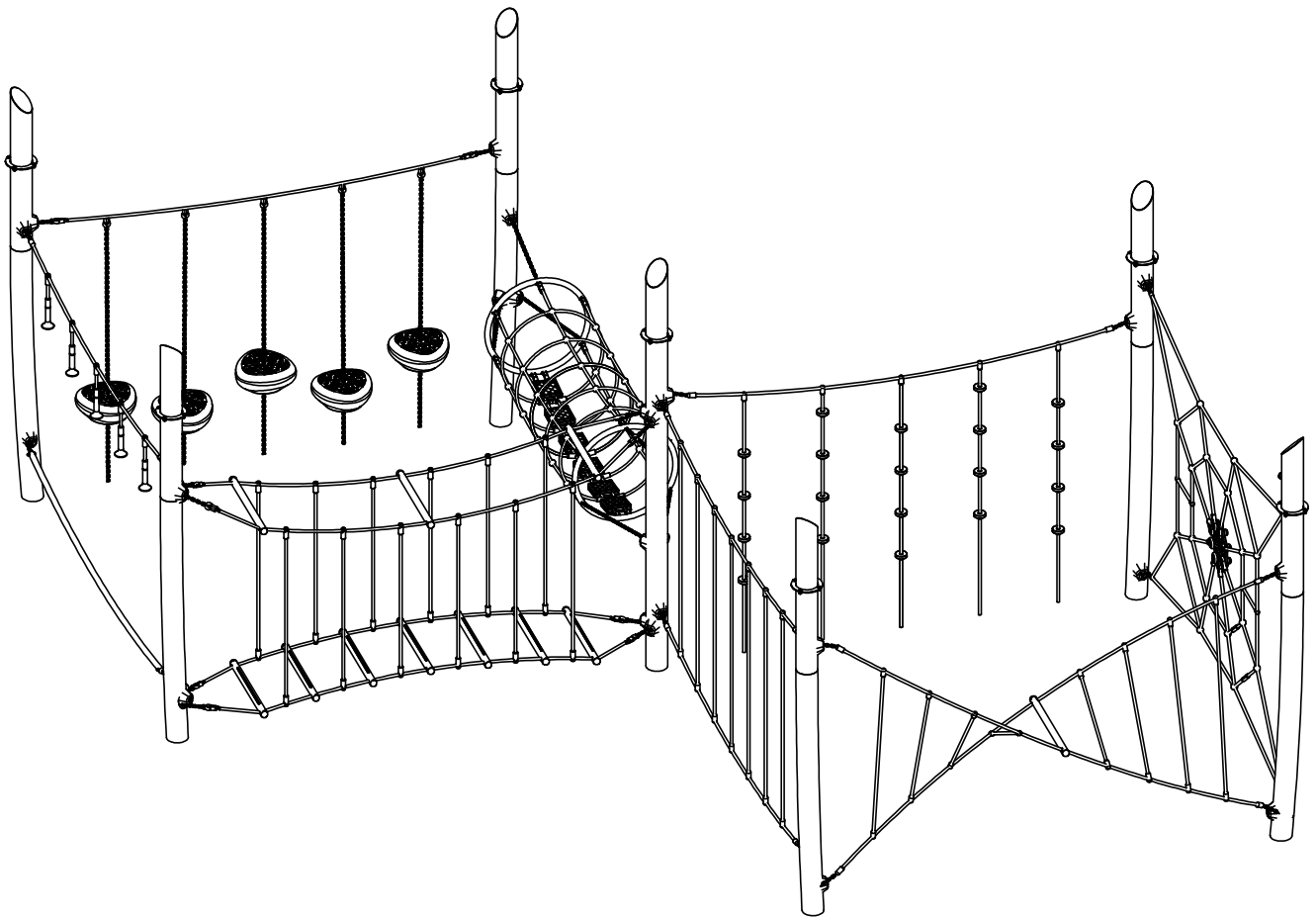
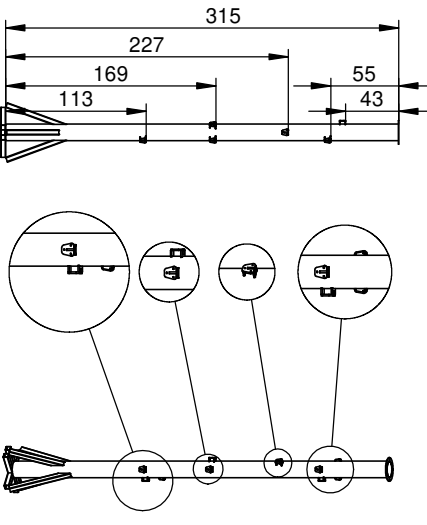
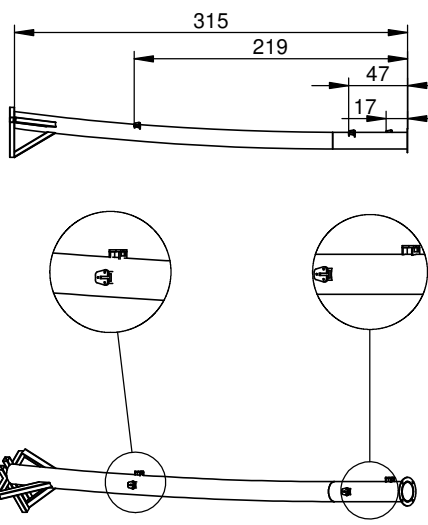
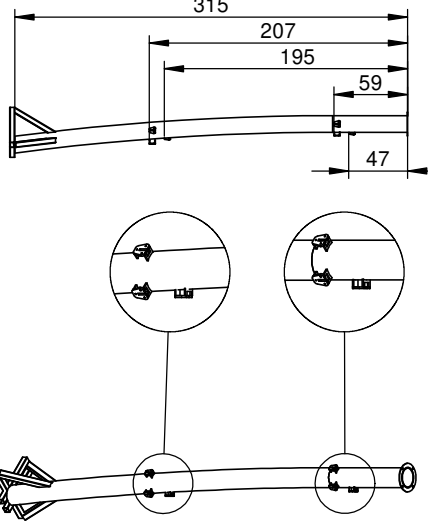
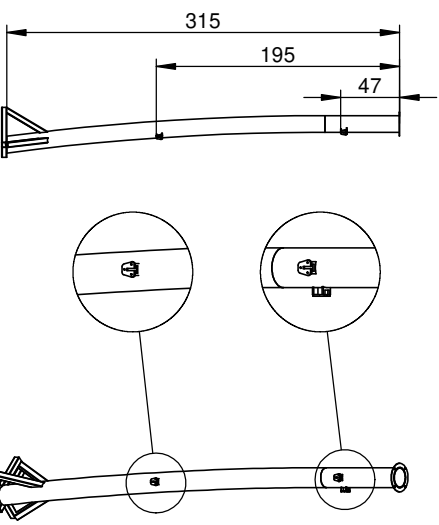
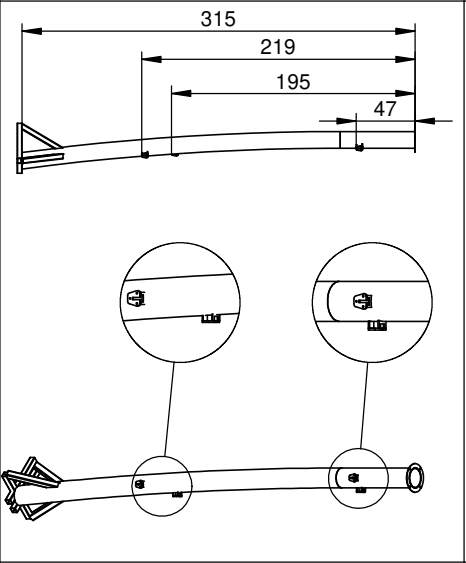
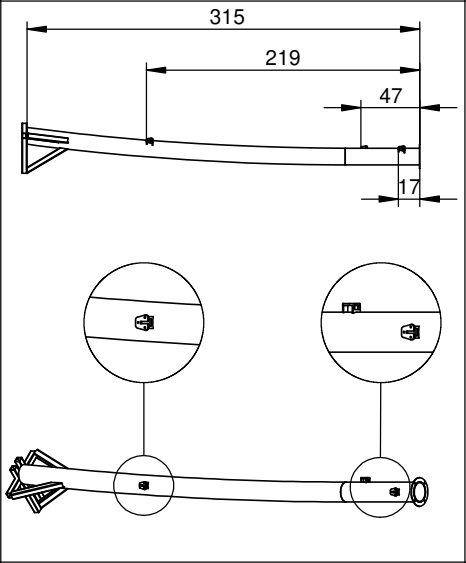
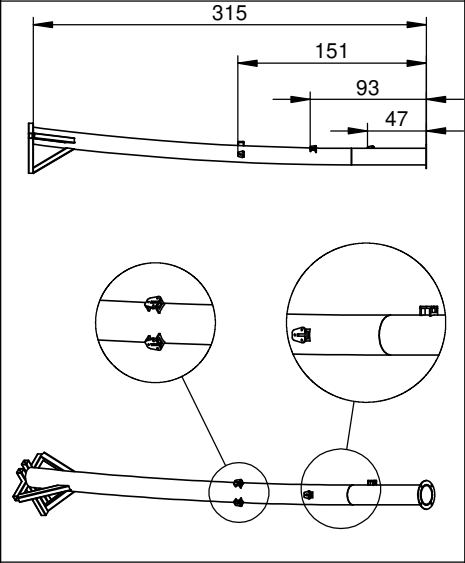
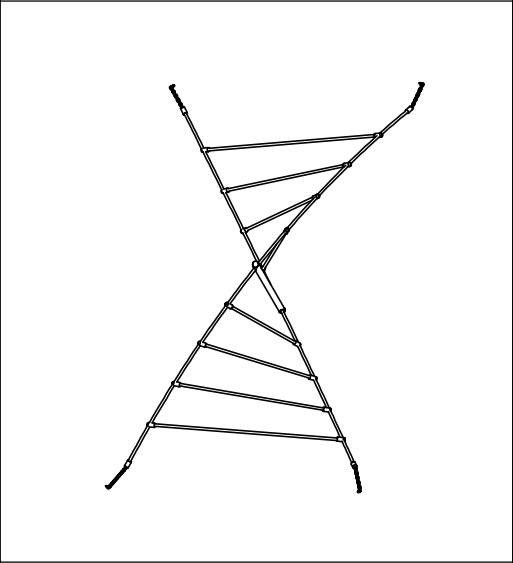

9075N

NR	ELEMENT	9075N
E1		1
E2		1
E3		1
E4		1

NR	ELEMENT	9075N
E5		1
E6		1
E7		1
E8		1

NR

ELEMENT

E9

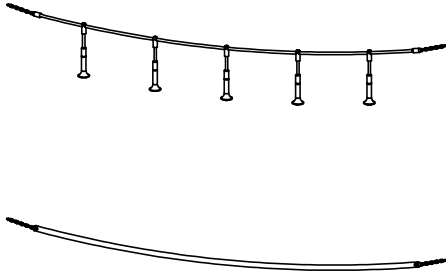

1

E10

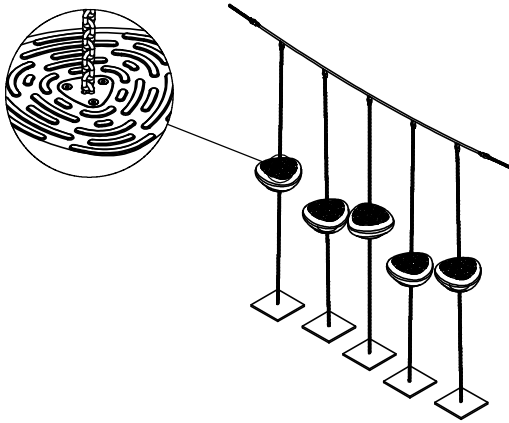

1

E11

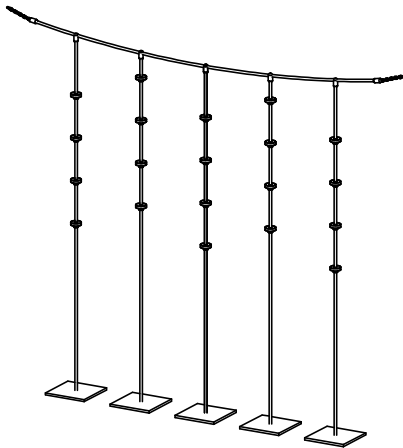

1

E12

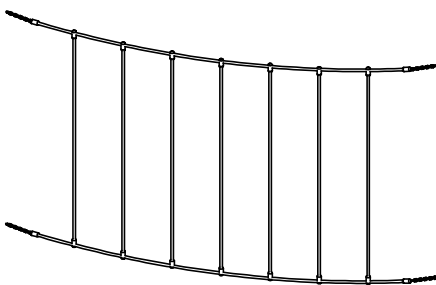

1

NR	ELEMENT	
E13		1
E14		1
E15		1
E16		1

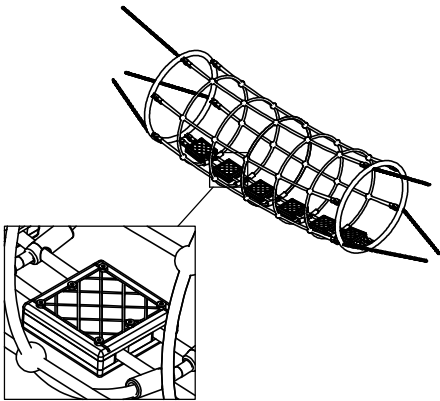
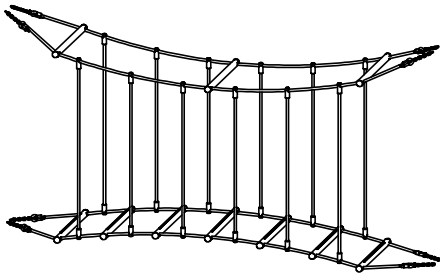
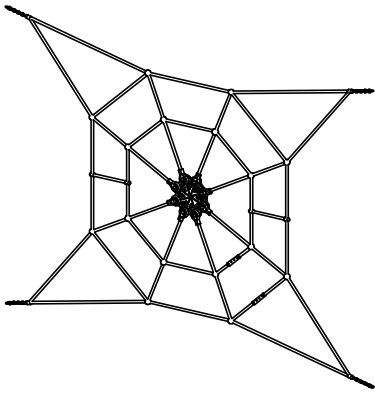

9075N

NR

ELEMENT

E17

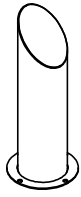
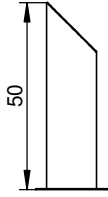

1

E18

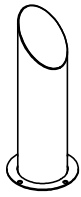
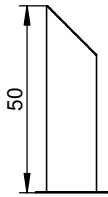

2

E19

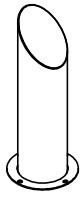
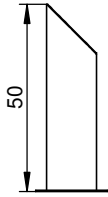

1

E20

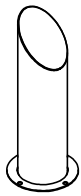
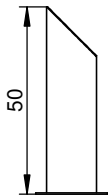

1

E21

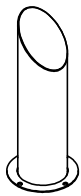
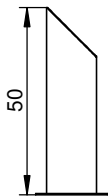

1

E22

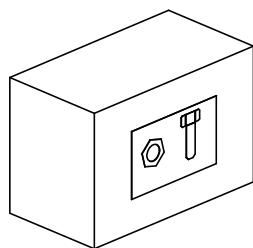

1

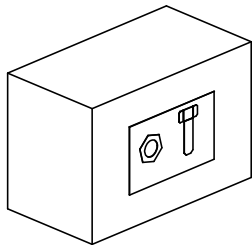

9075N

Nr	Element	DIN	ELEMENT	Σ
4		DIN 125	10x20	56
24		ISO 7380	M6x16	102
49		-	PRT	34
57		DIN 1587	M10	28
58		-	LOCTITE	1
154		ISO 7380	M10x20	28
213		-	Z_NA_1	1
214		-	Z_NA_2	1

9075N

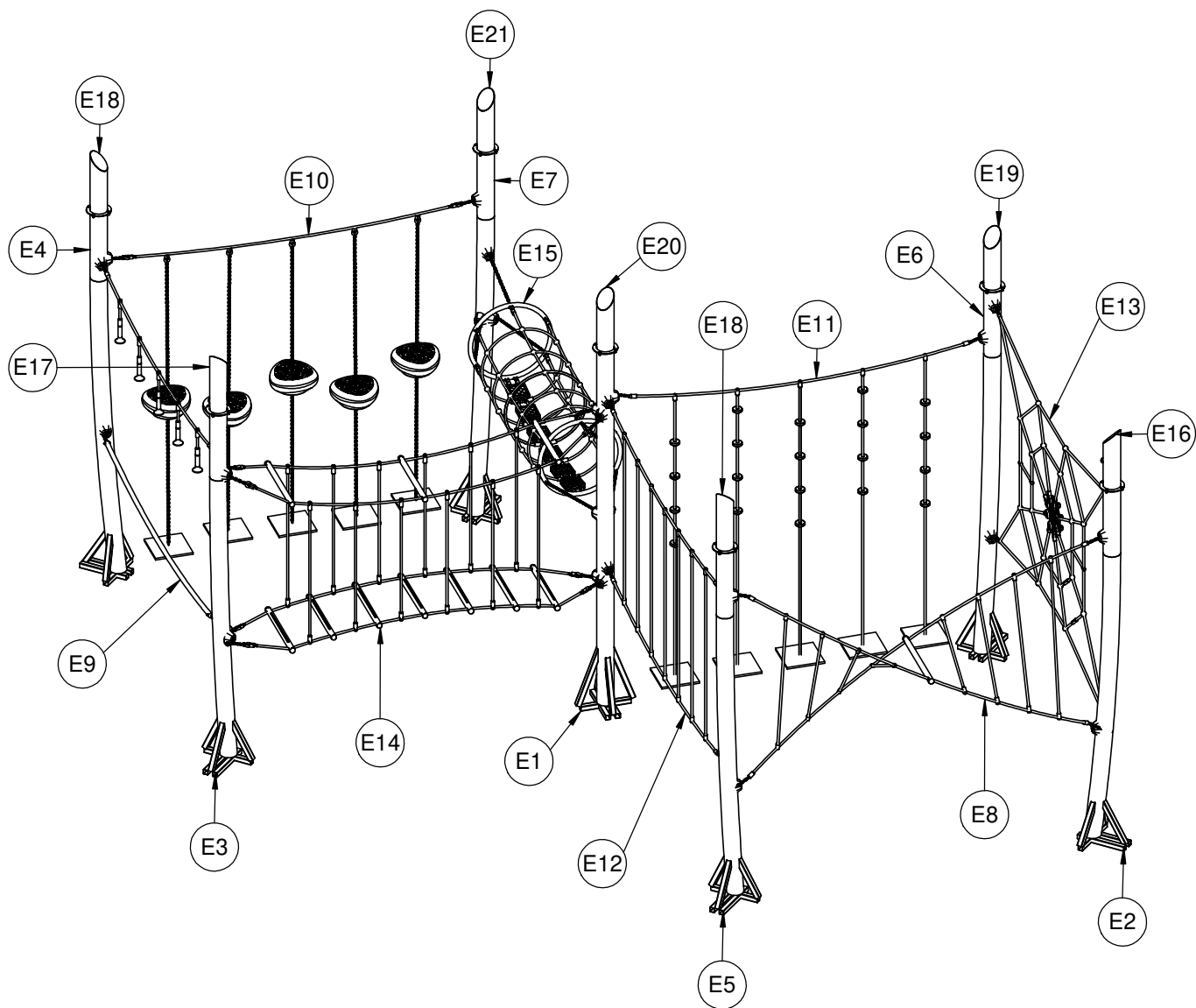

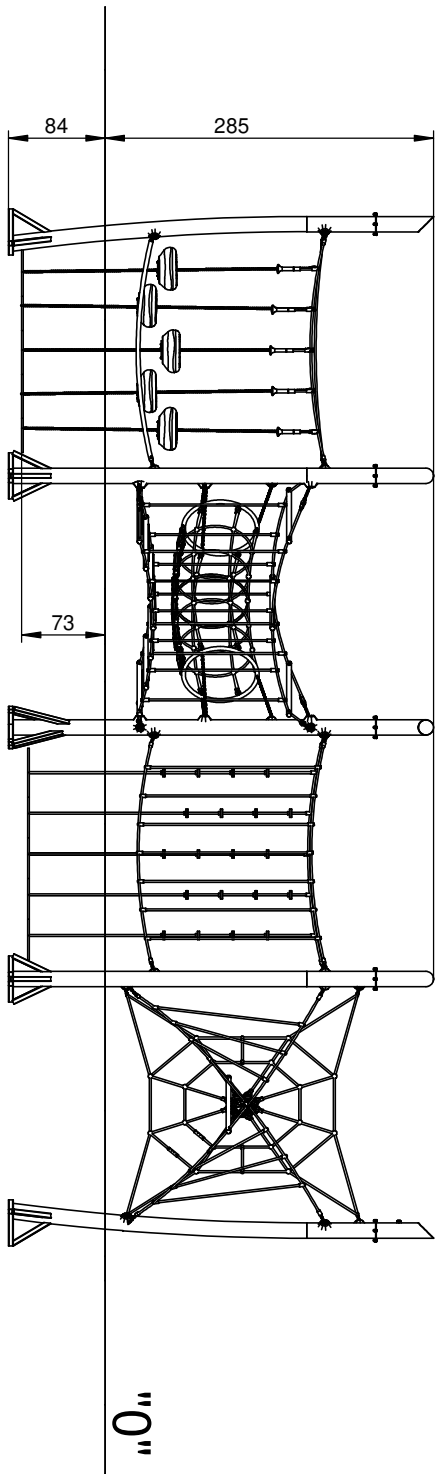

1

9075N

Nr	Σ	Element		
4	8	⊙	DIN 125	10x20
57	4	⊕	DIN 1587	M10
154	4	⌋	ISO 7380	M10x20

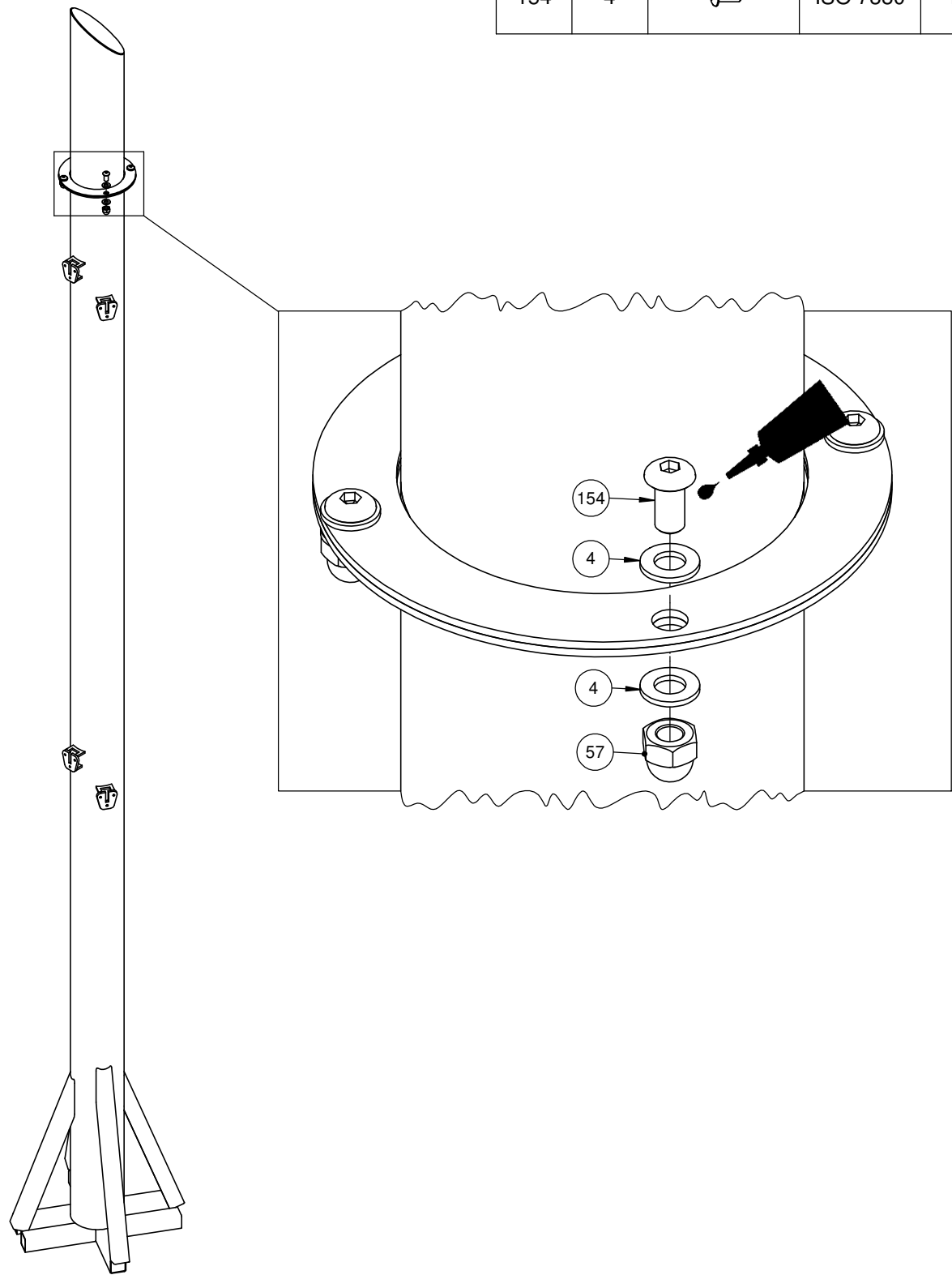

2 9075N

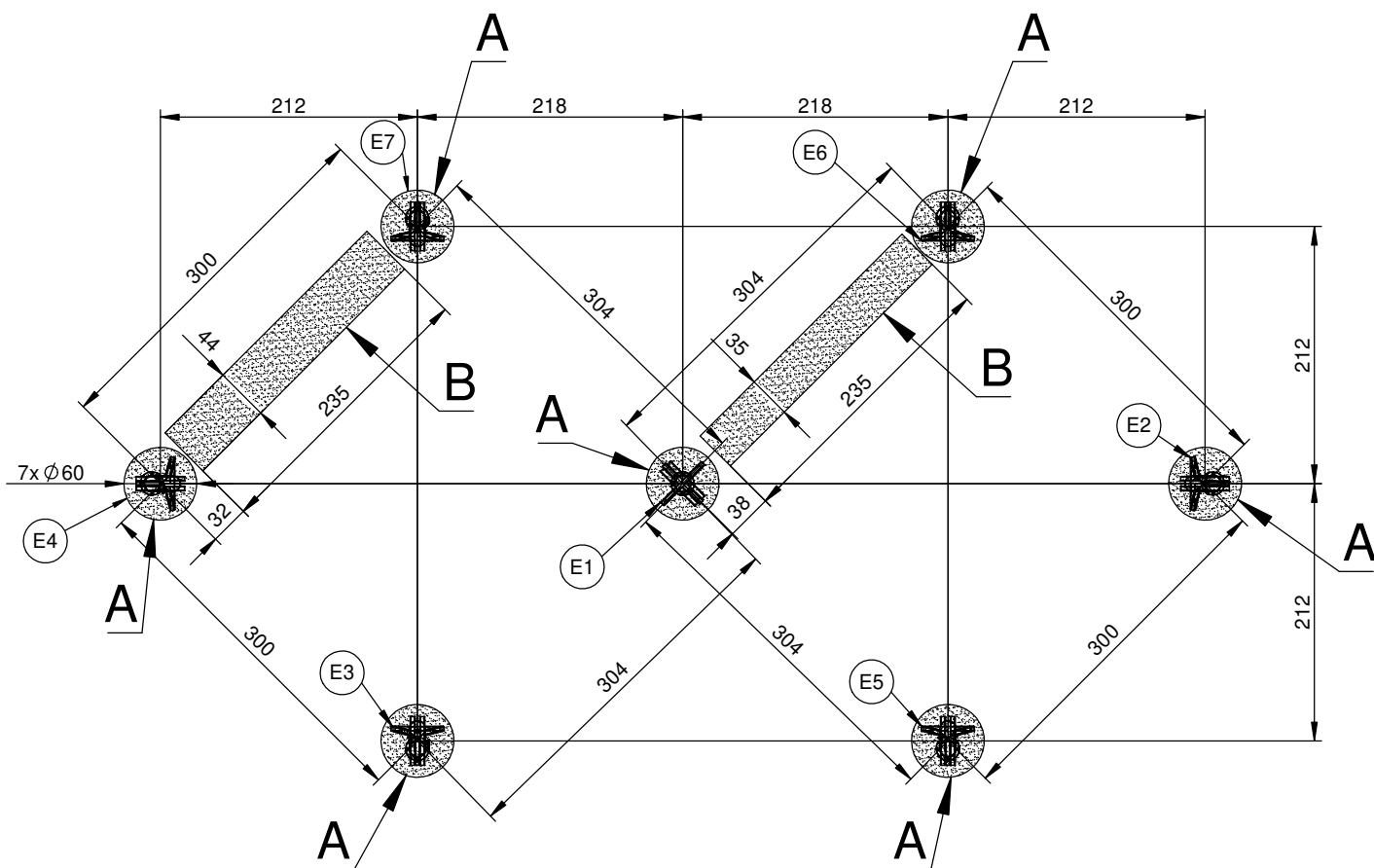
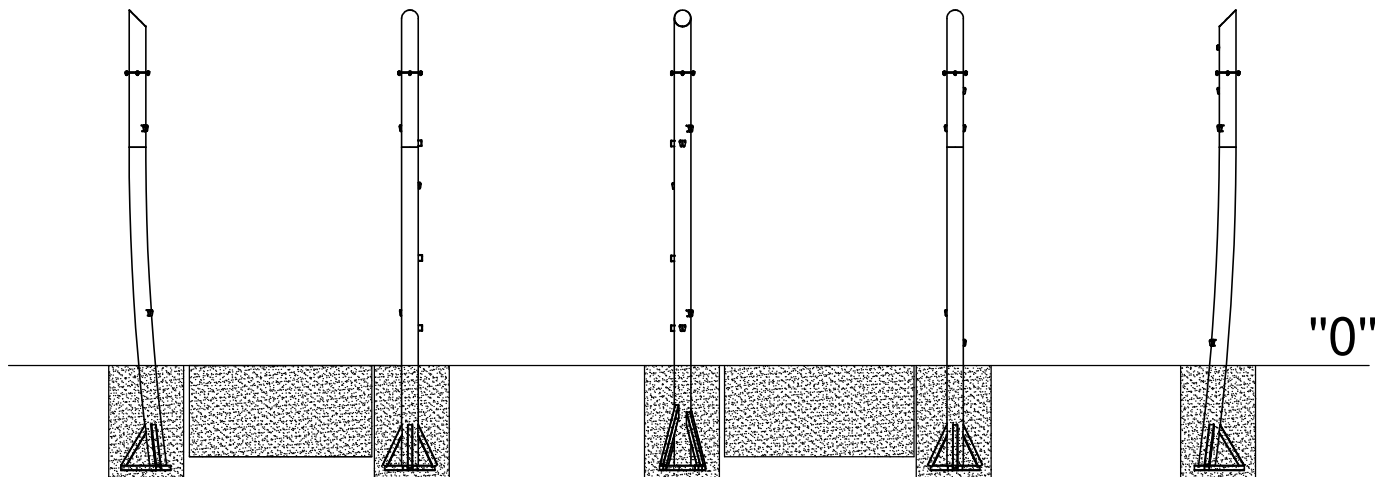
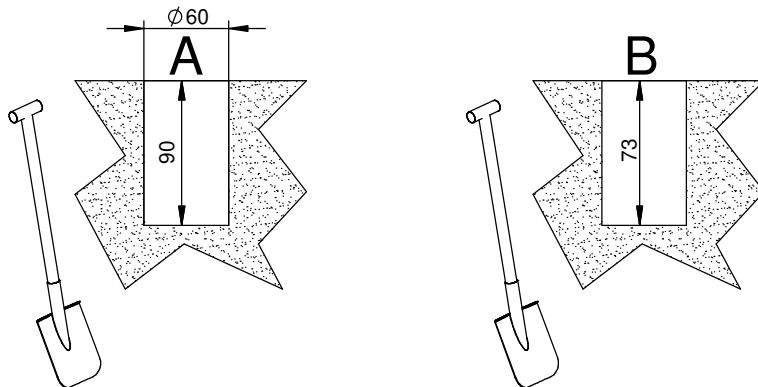

3A

9075N

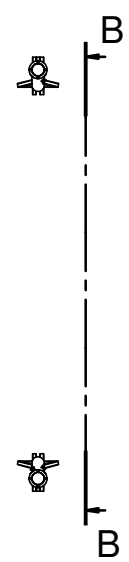
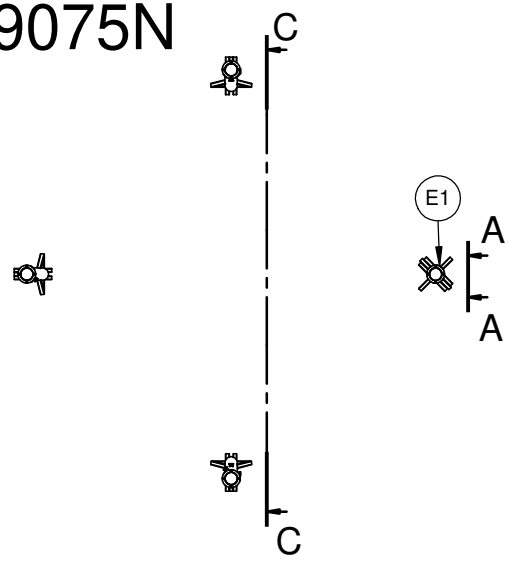

A-A (1 : 30)

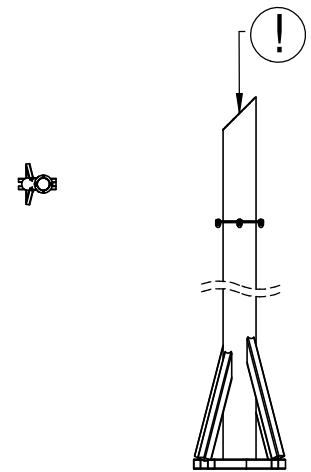

B-B (1 : 65)

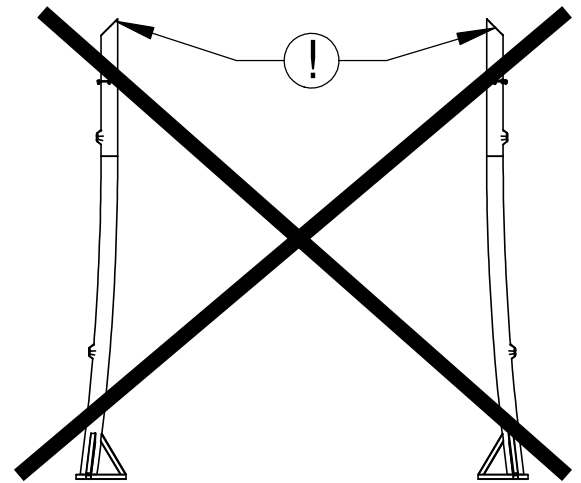
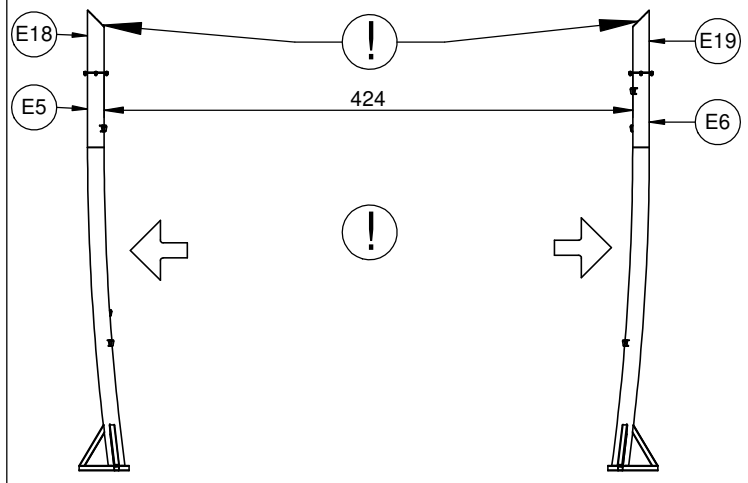

C-C (1 : 65)

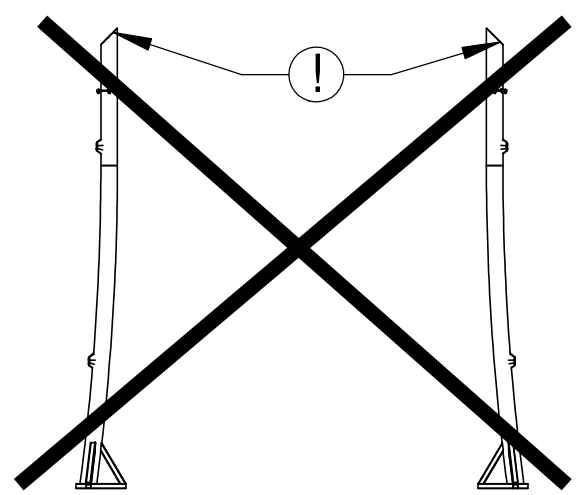
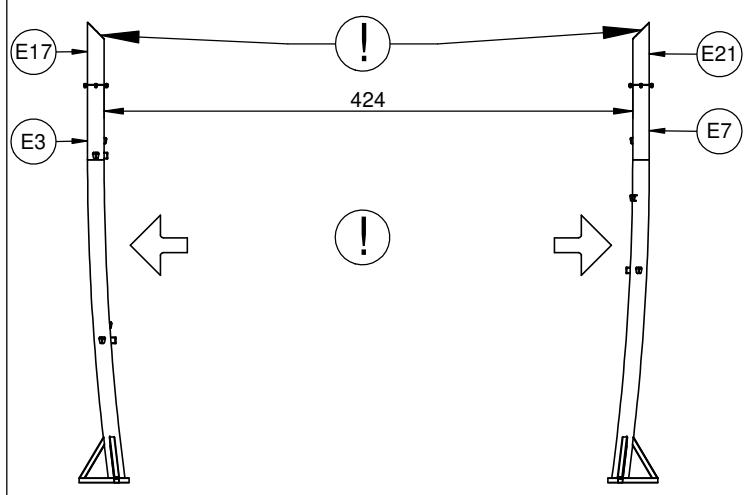

3B

9075N

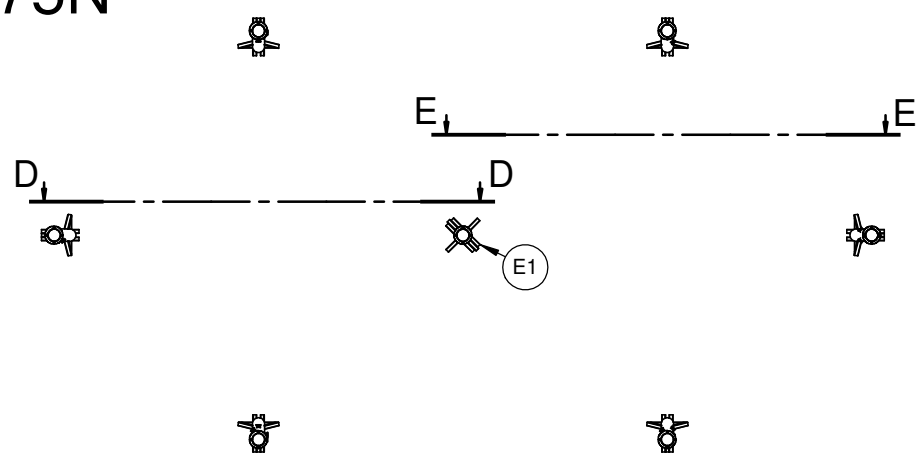

D-D (1 : 65)

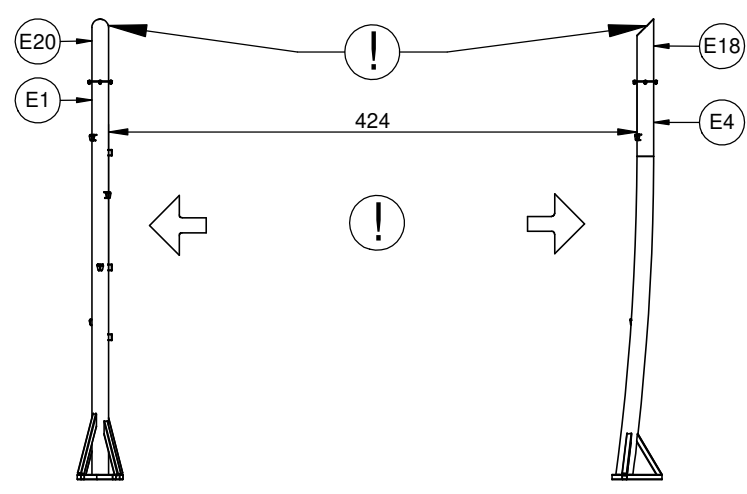

E-E (1 : 65)

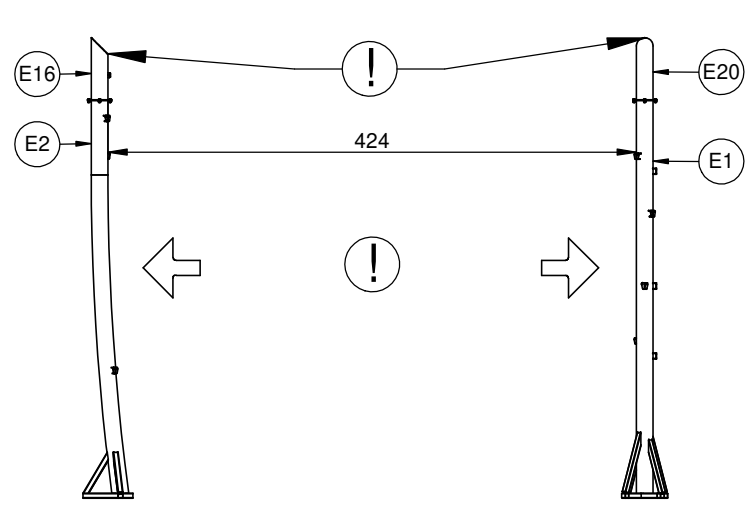

4

9075N

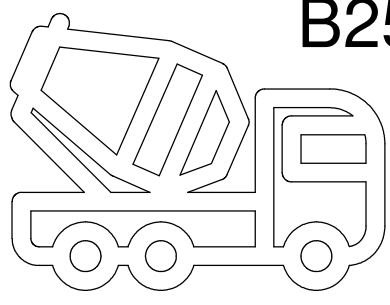
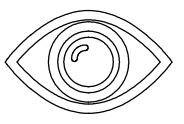

B25 1m³

min. 48H

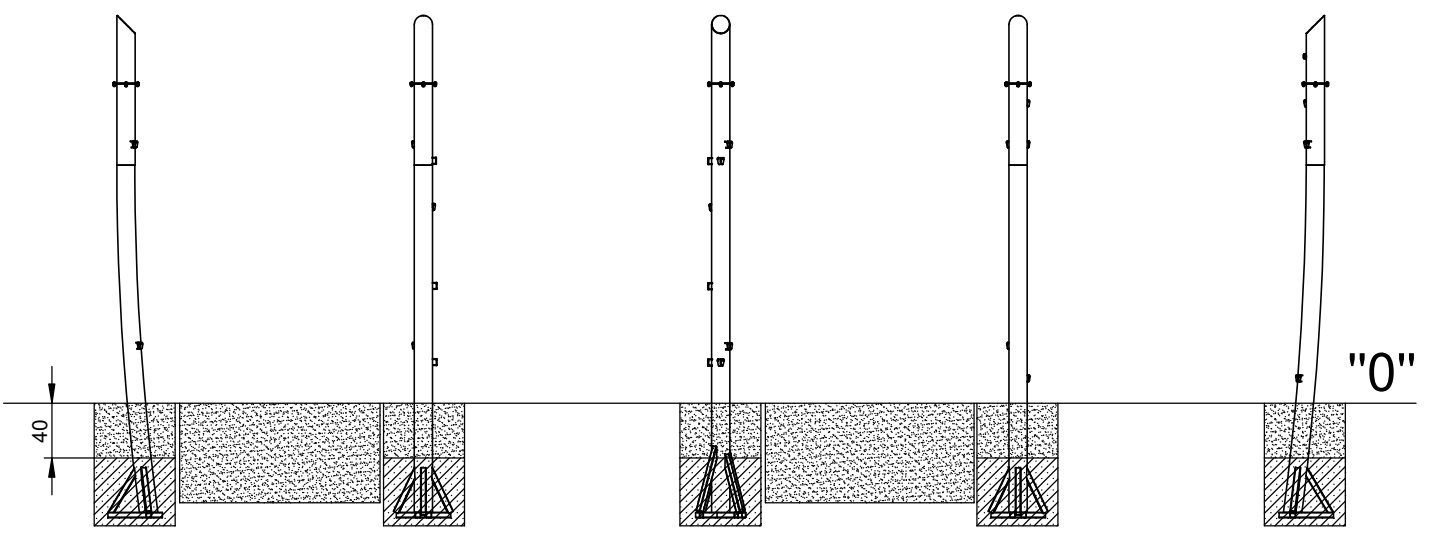
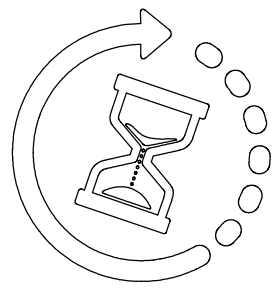

5A

9075N

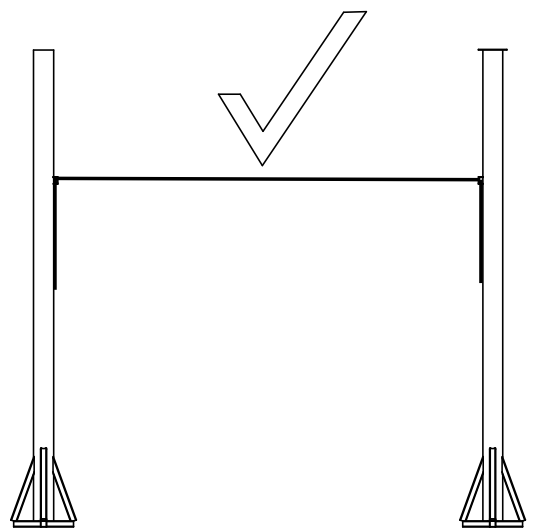
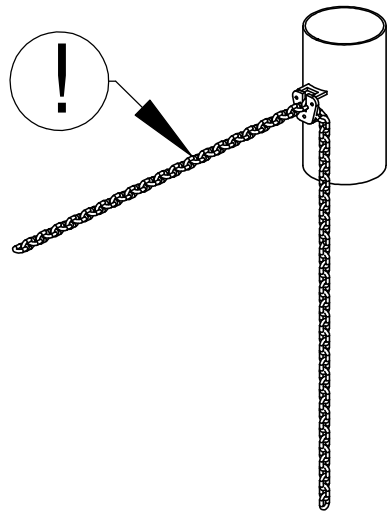
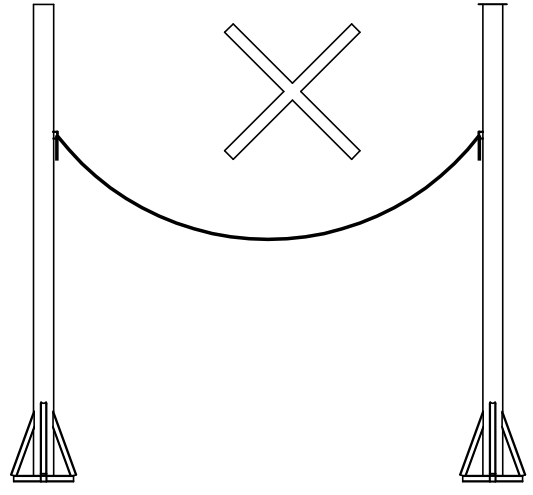
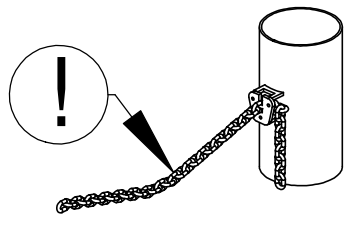

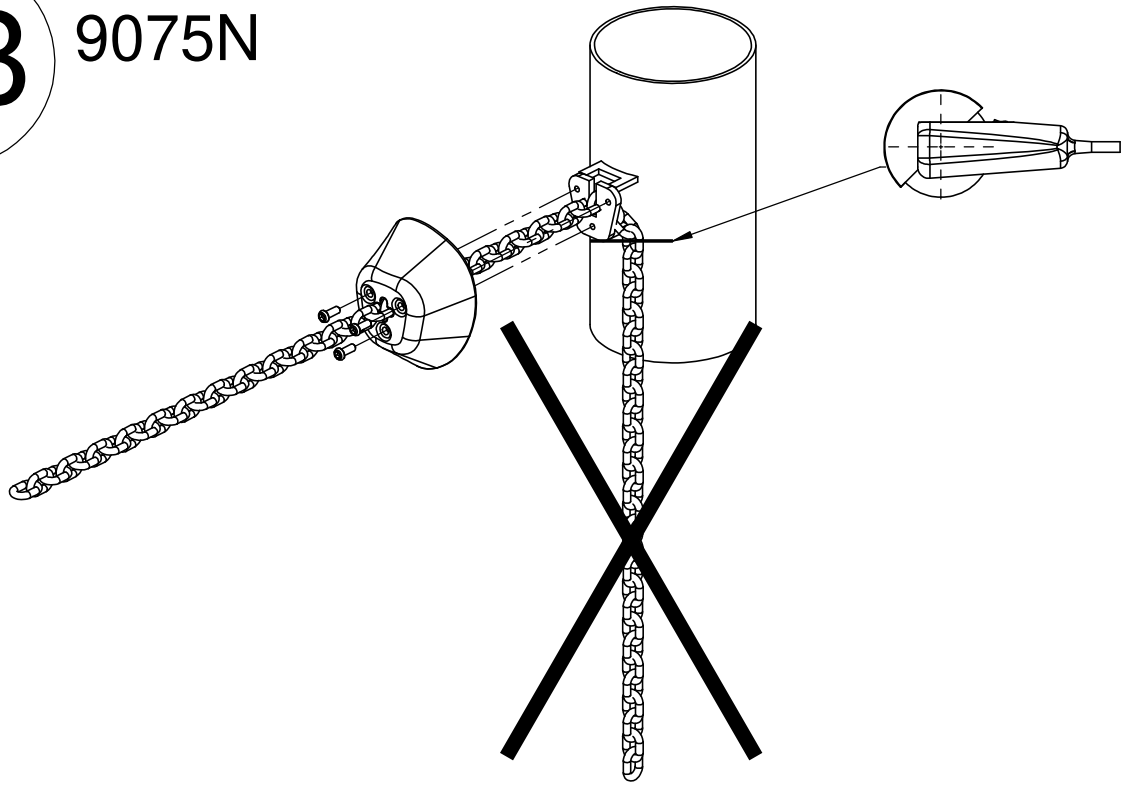

5B

9075N



5C

9075N

Nr	Σ	Element	DIN	ELEMENT
24	3		ISO 7380	M6x16
49	1		-	PRT

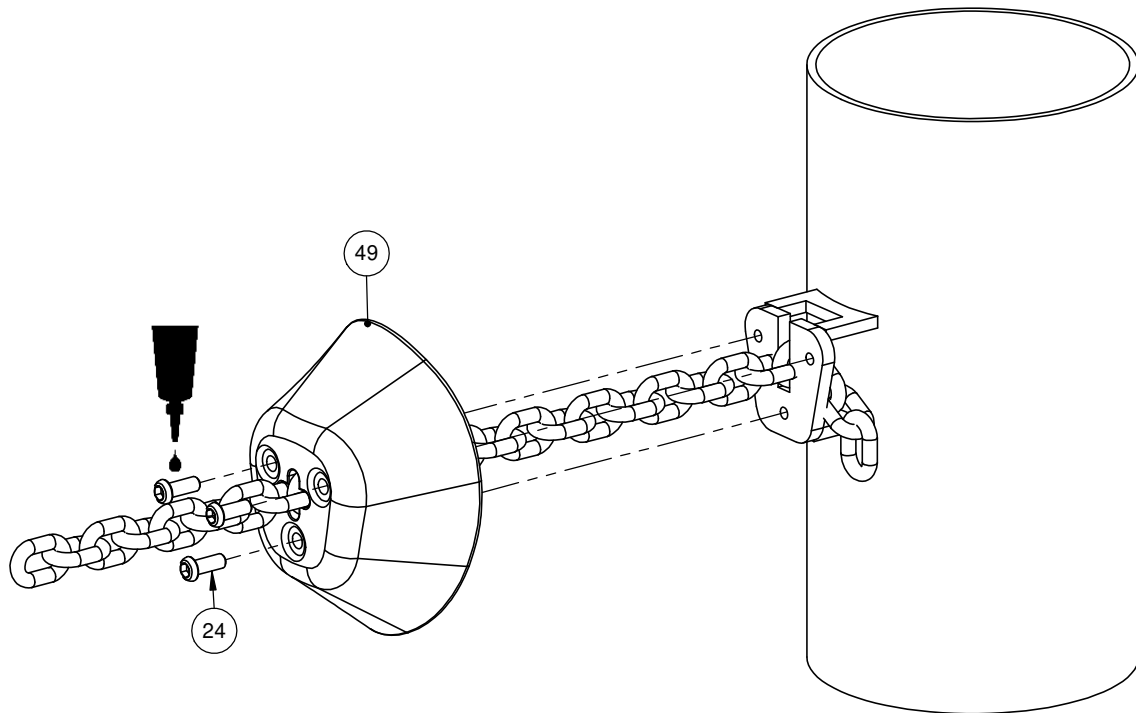

6

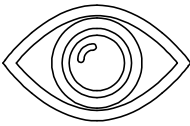

9075N

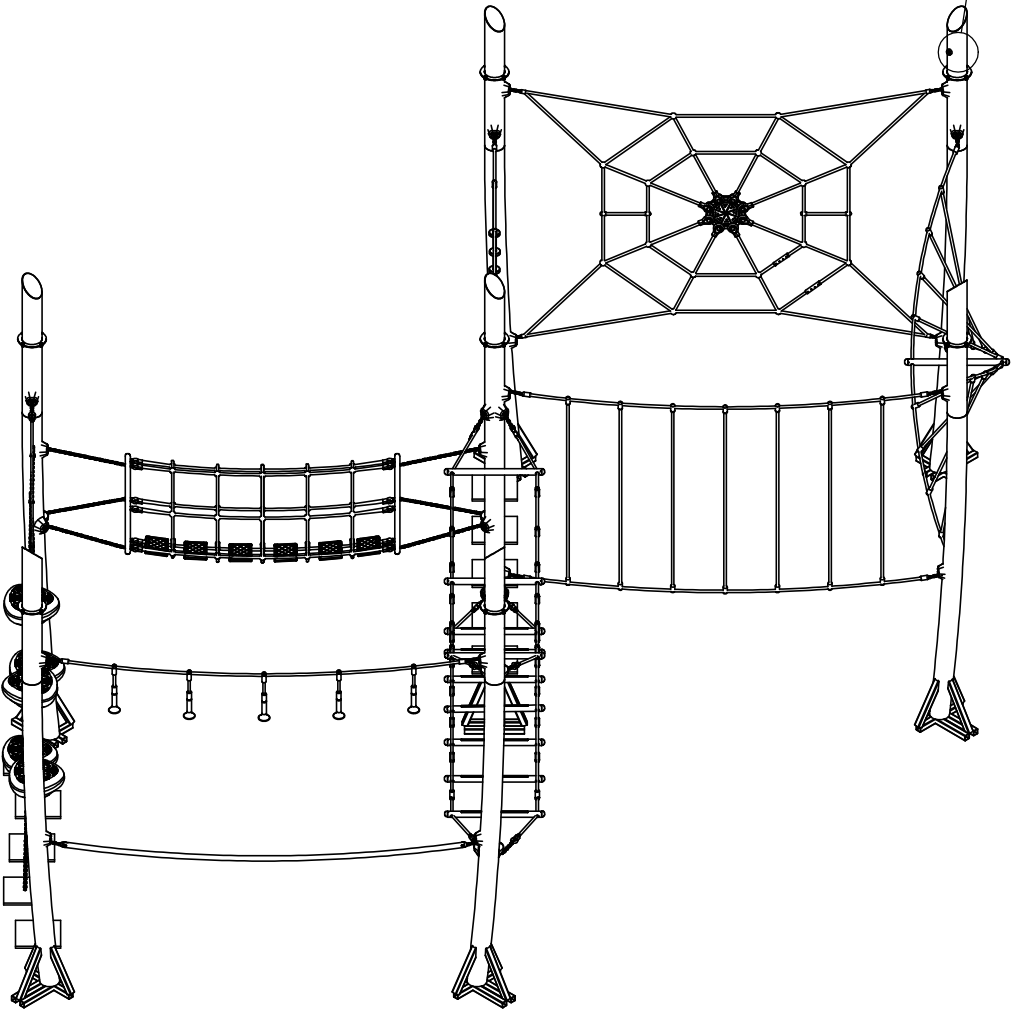
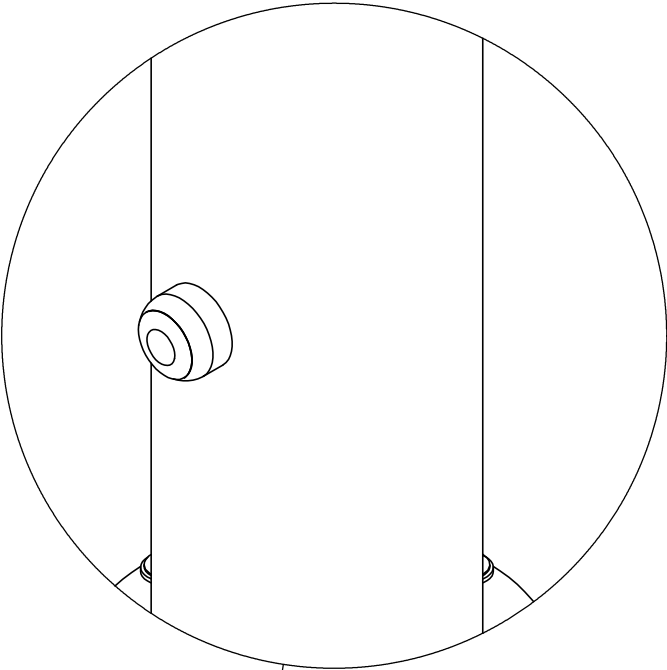

INST_Z_1



INST_Z_1

Nr	Σ	Element		
213	1		-	Z_NA_1
214	1		-	Z_NA_2

