

9076

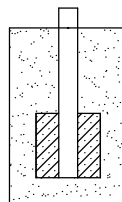
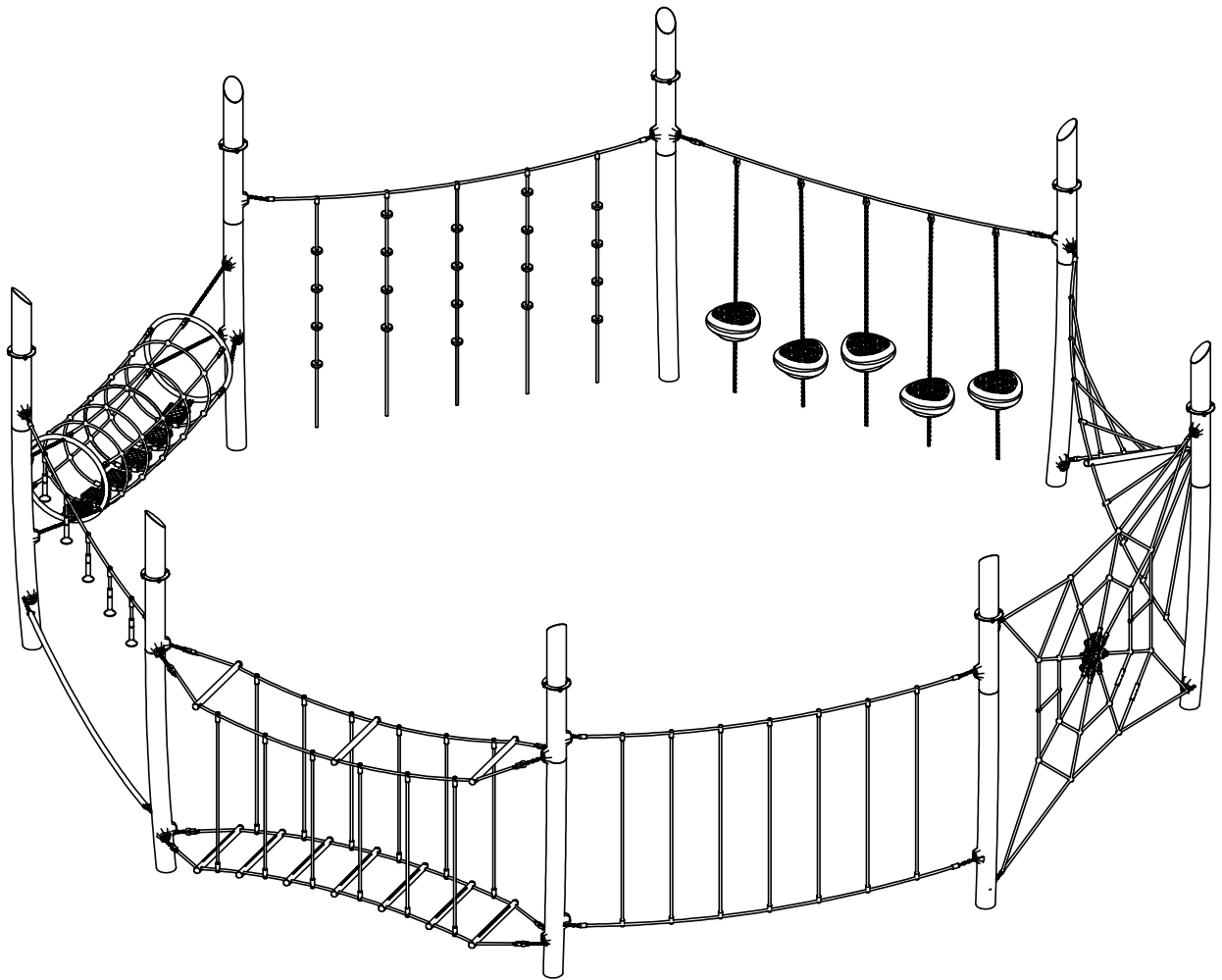

9076N

NR

ELEMENT

9076N

E1

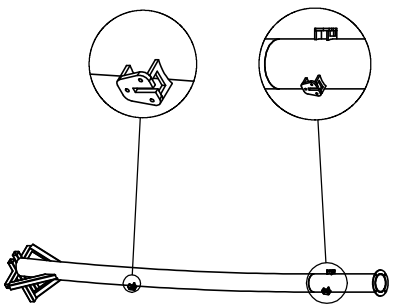
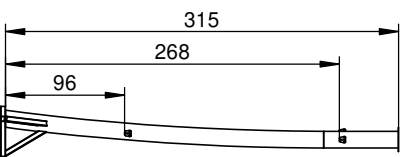

1

E2

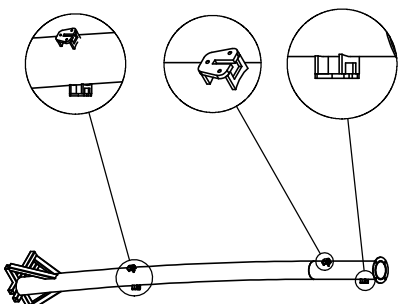
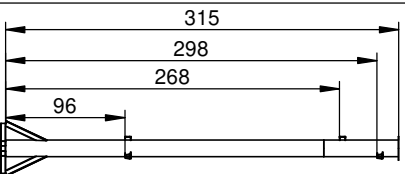

1

E3

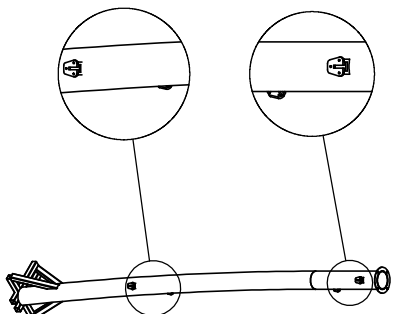
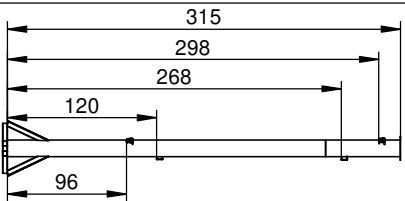

1

E4

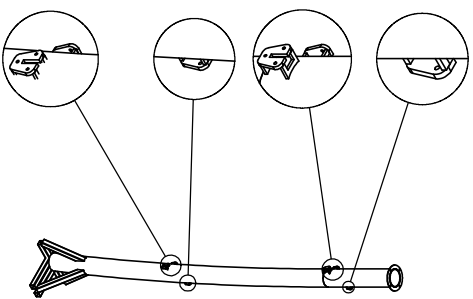
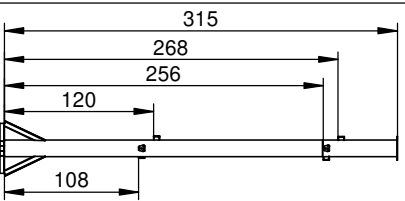

1

NR

ELEMENT

9076N

E5

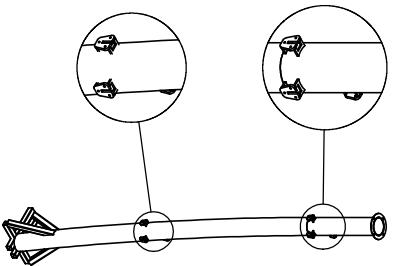
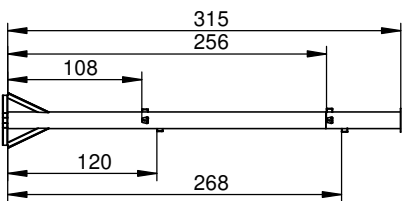

1

E6

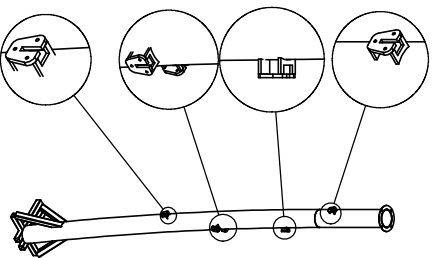
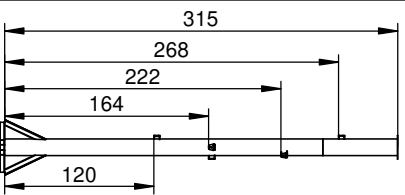

1

E7

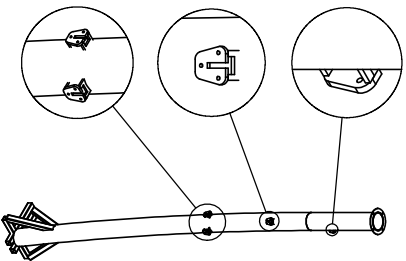
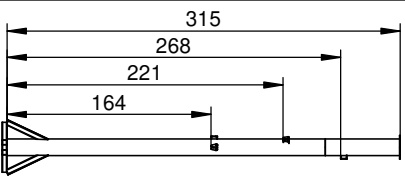

1

E8

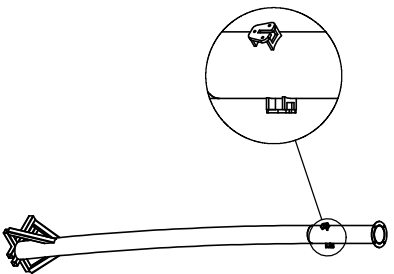
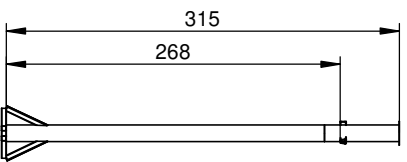

1

NR

ELEMENT

E9

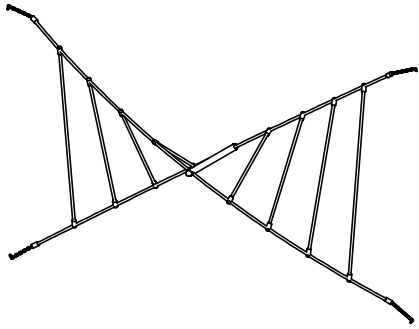

1

E10

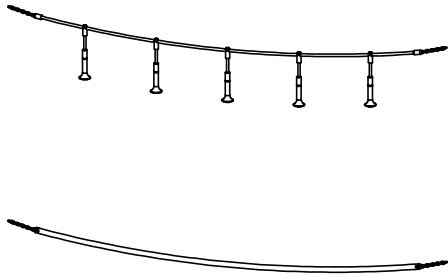

1

E11

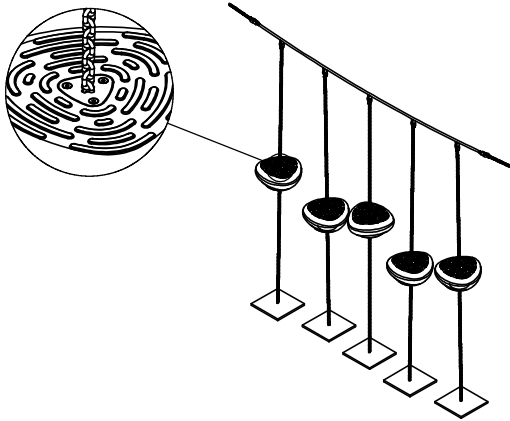

1

E12

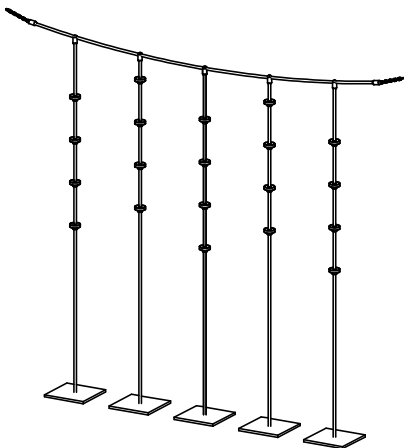

1

NR	ELEMENT	
E13		1
E14		1
E15		1
E16		1

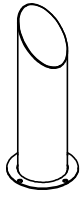
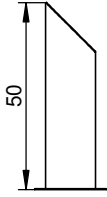
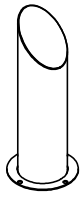
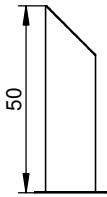
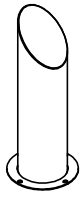
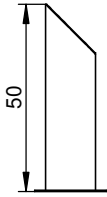
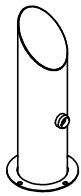
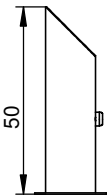
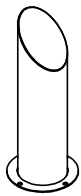
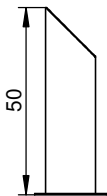
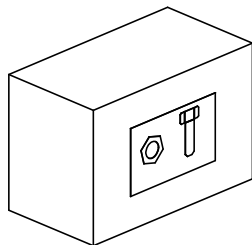
NR ELEMENT**E17****2****E18****2****E19****2****E20****1****E21****1****E22****1**

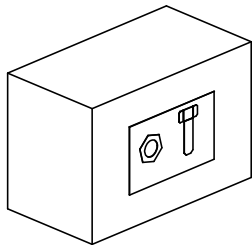

9076N

Nr	Element	DIN	ELEMENT	Σ
4		DIN 125	10x20	64
24		ISO 7380	M6x16	105
49		-	PRT	35
57		DIN 1587	M10	32
58		-	LOCTITE	1
154		ISO 7380	M10x20	32
213		-	Z_NA_1	1
214		-	Z_NA_2	1

9076N

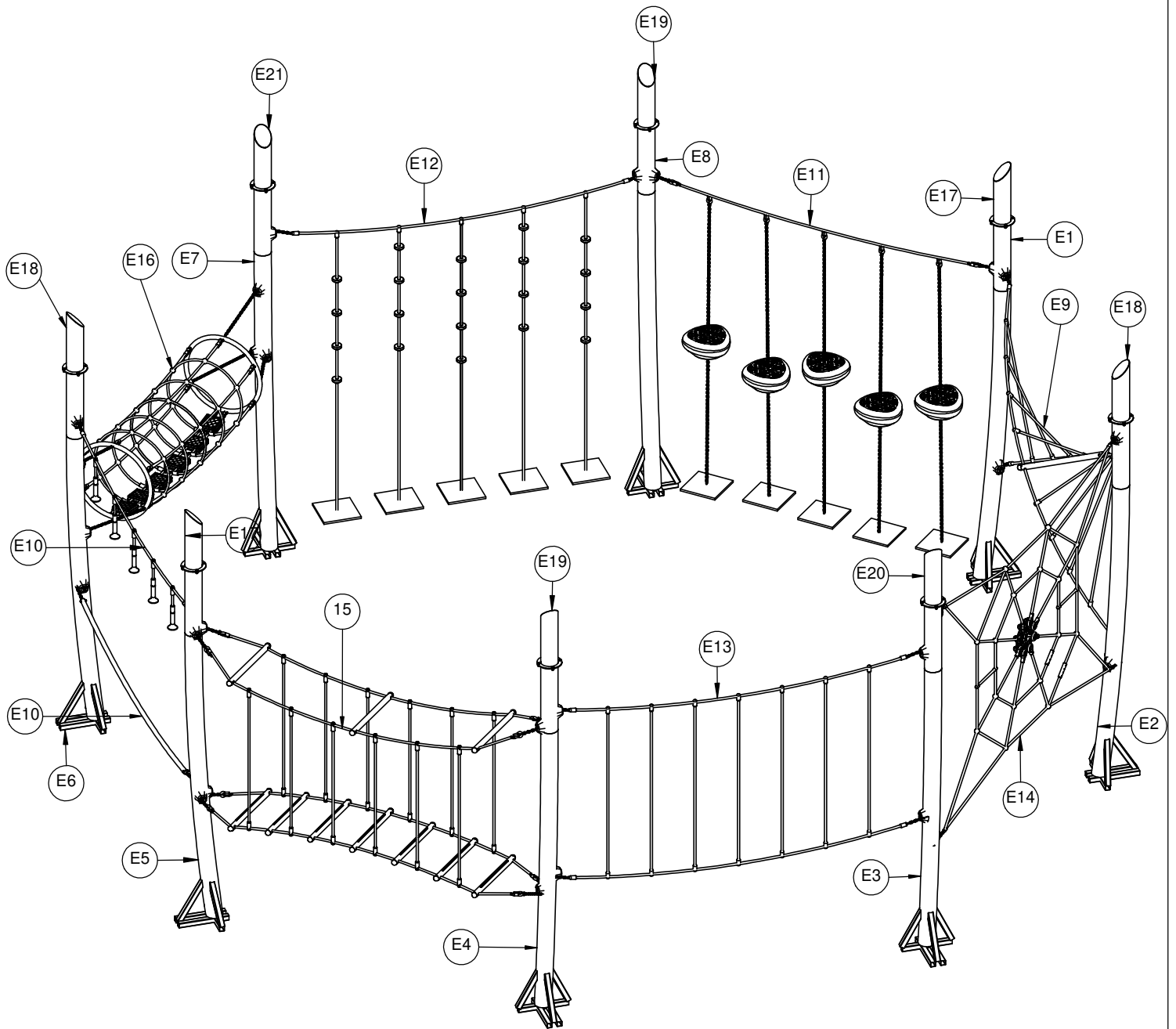

9076N

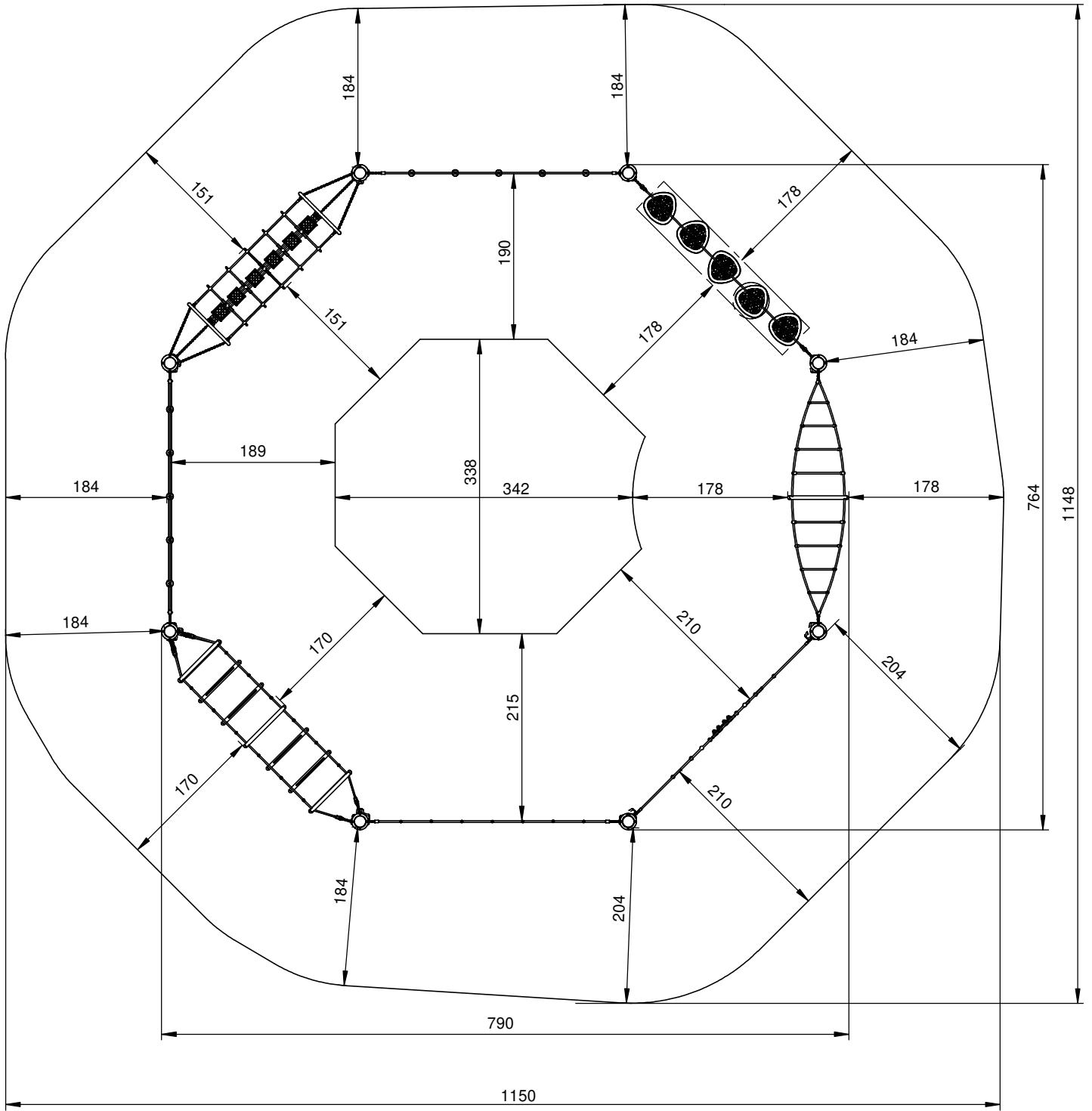

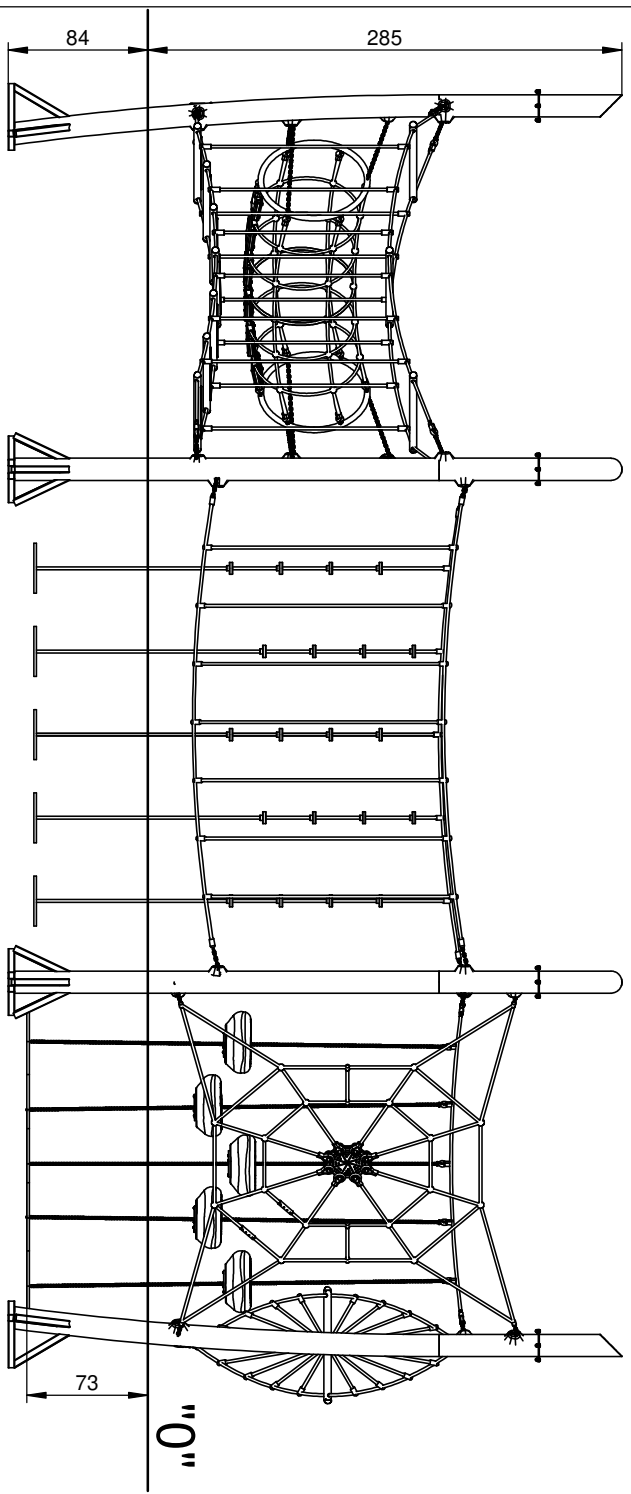

N976N

1

9076N

Nr	Σ	Element		
4	8	⊙	DIN 125	10x20
57	4	⊕	DIN 1587	M10
154	4	⌋	ISO 7380	M10x20

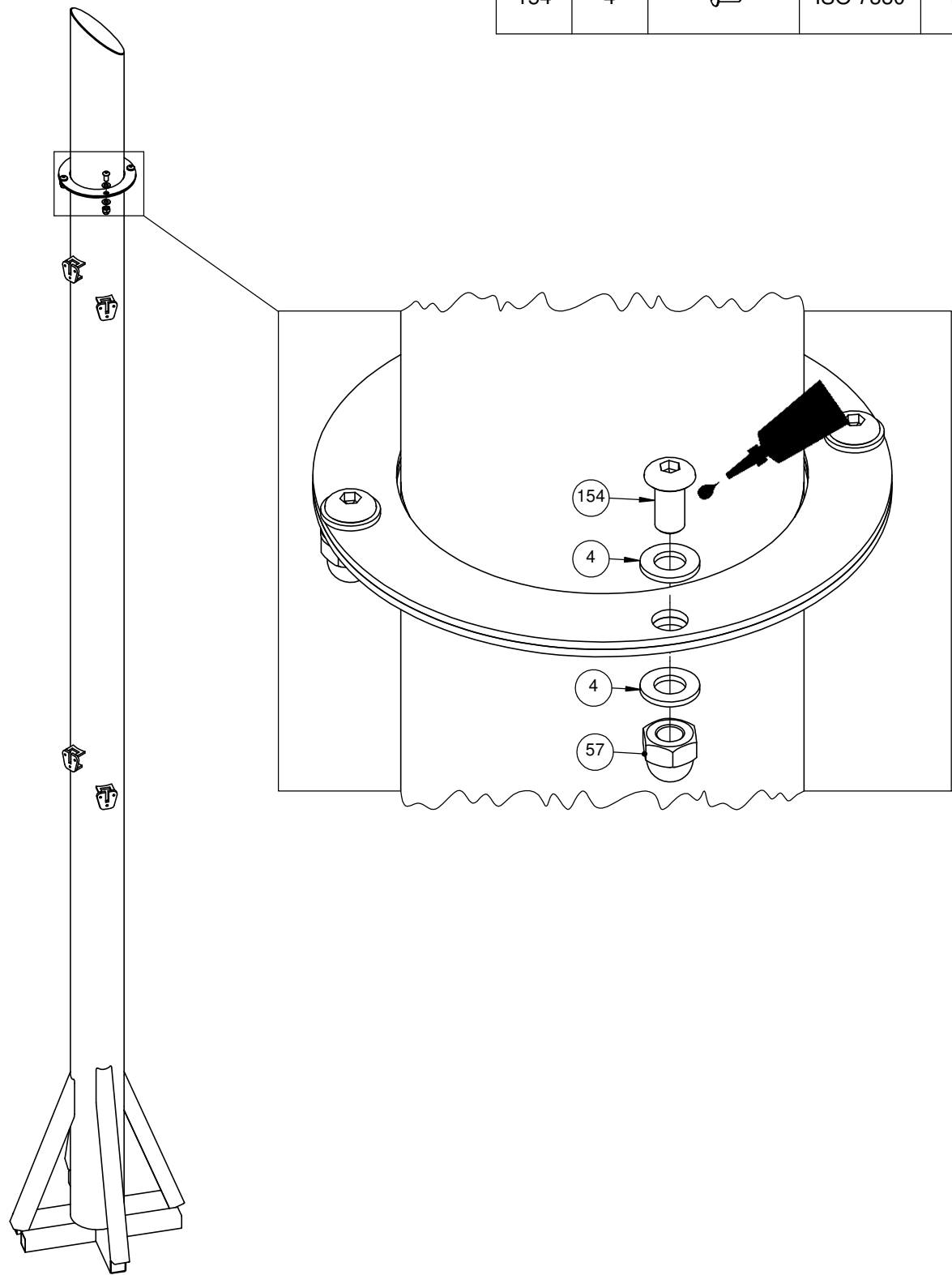

2 9076N

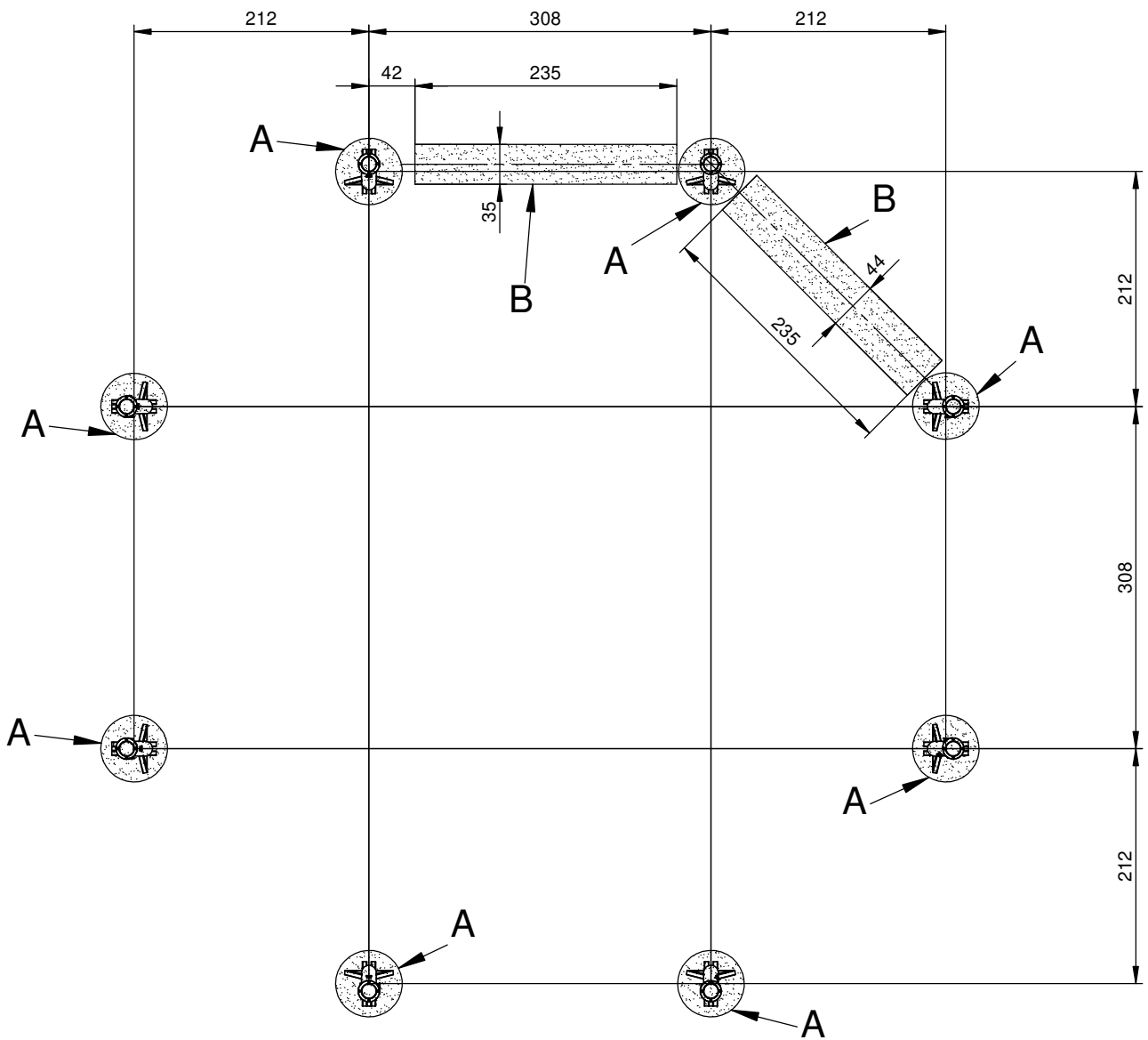
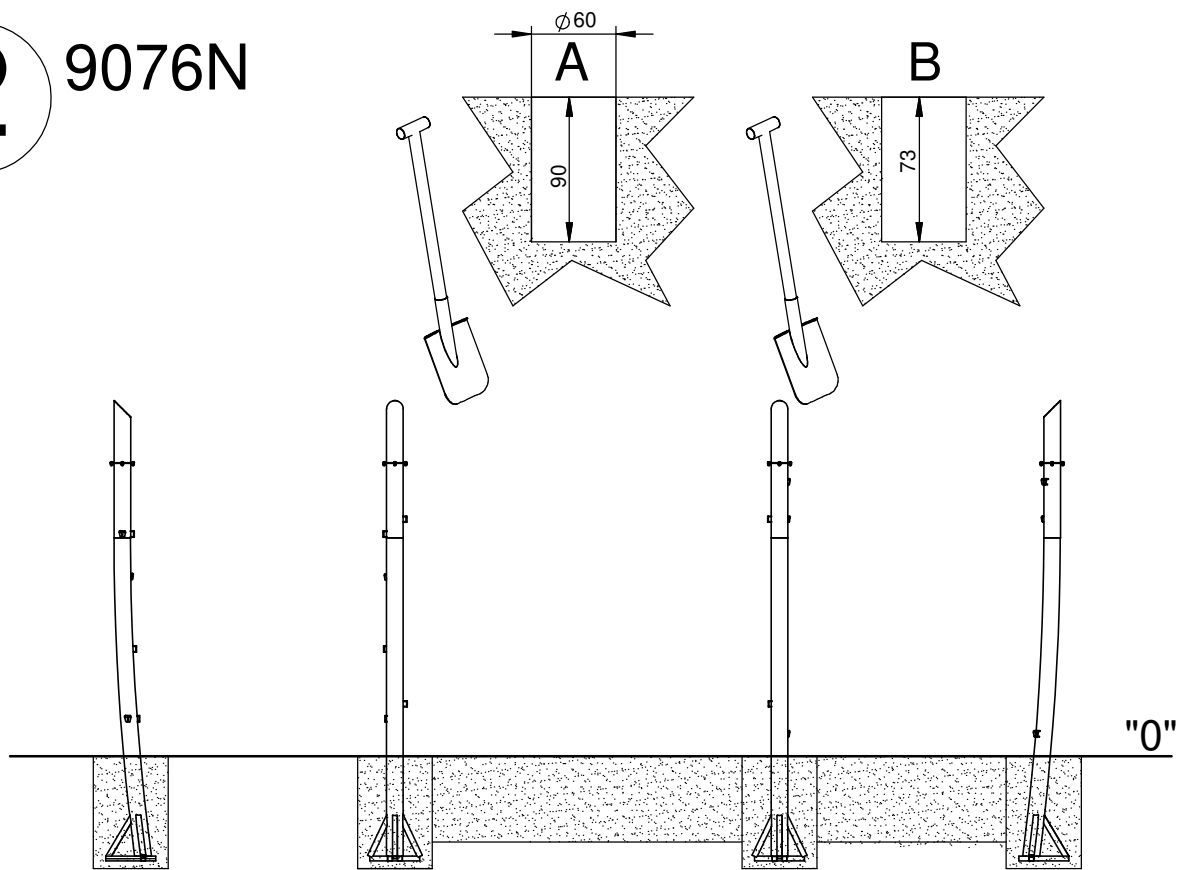

3 9076N

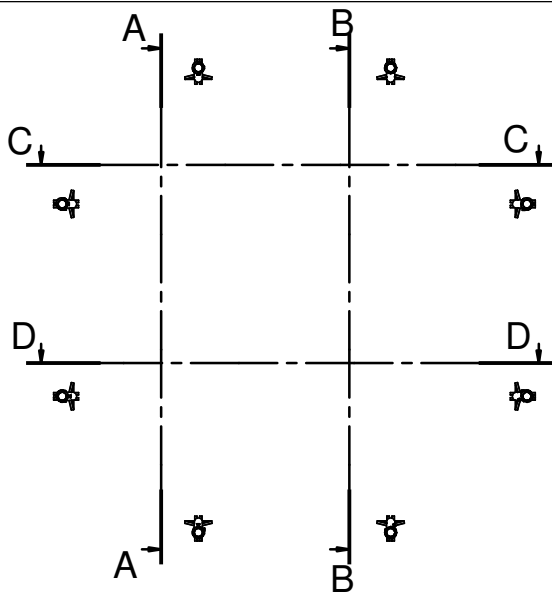

A-A (1 : 120)

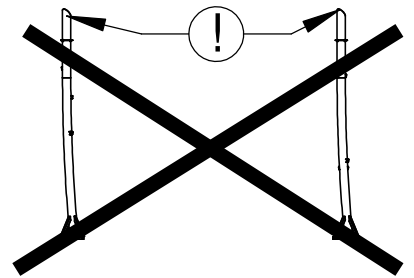
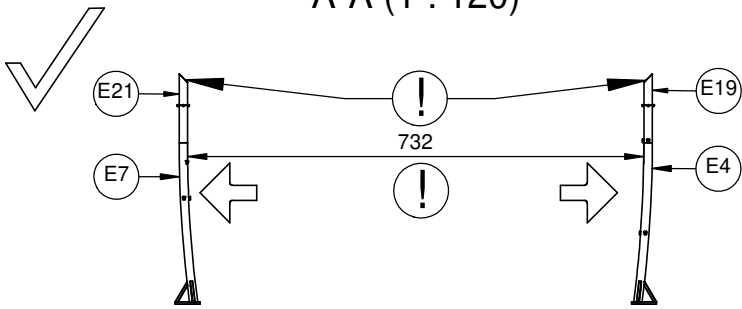

B-B (1 : 120)

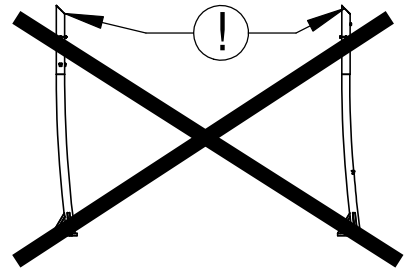
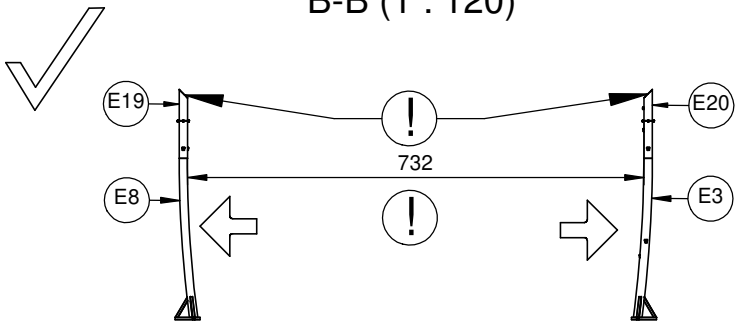

C-C (1 : 120)

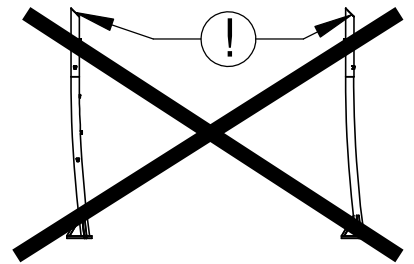
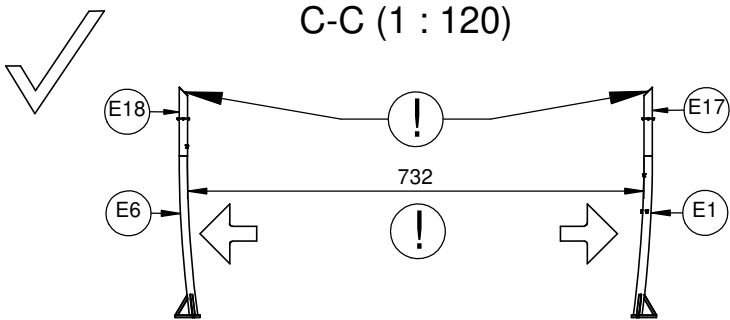

D-D (1 : 120)

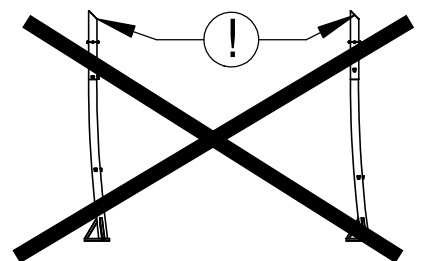
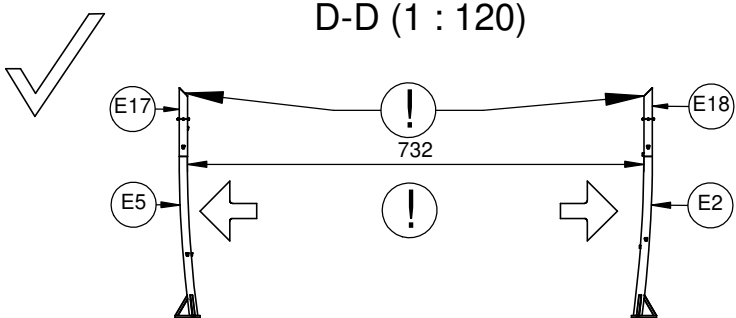

4

9076N

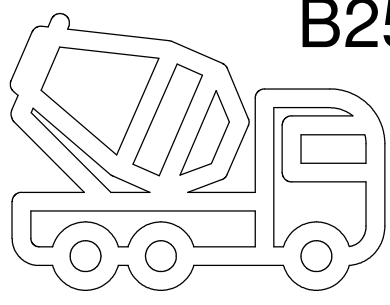
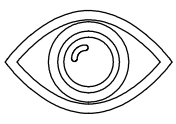

B25 1,2m³

min. 48H

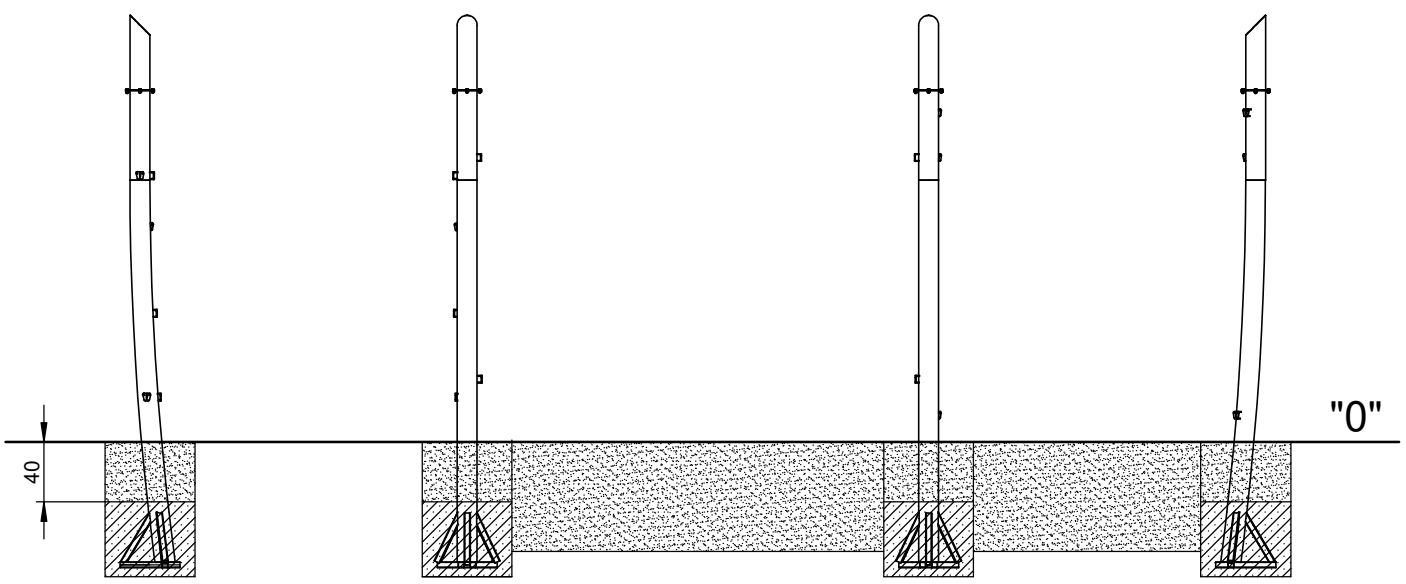
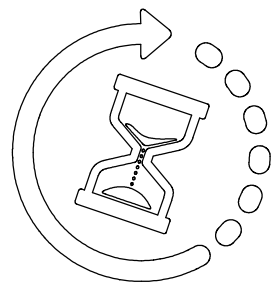

5A

9076N

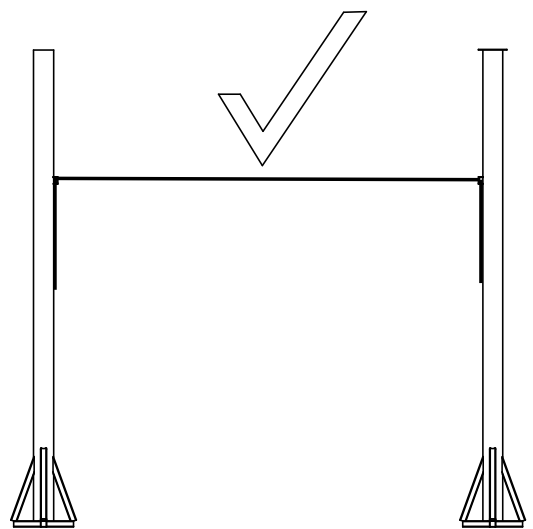
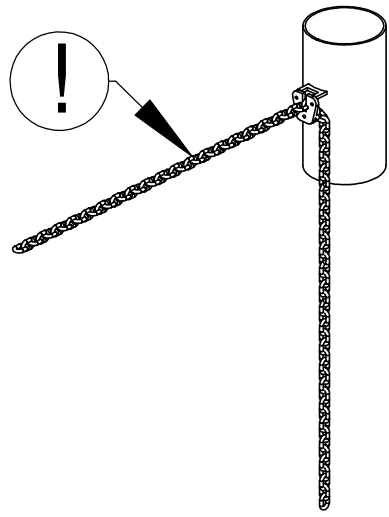
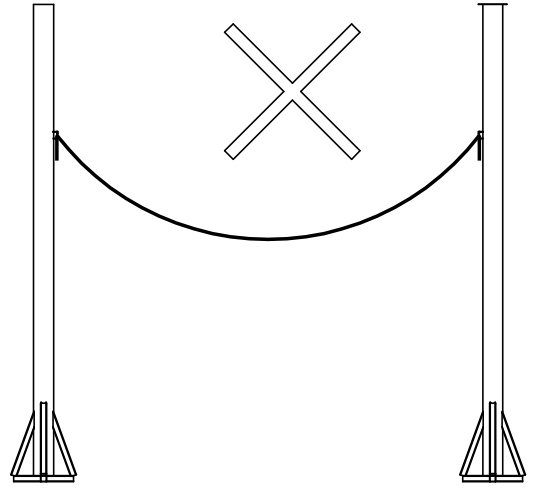
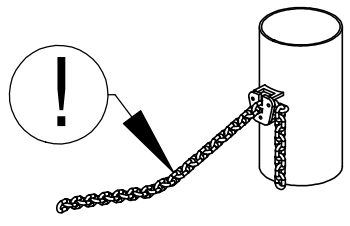

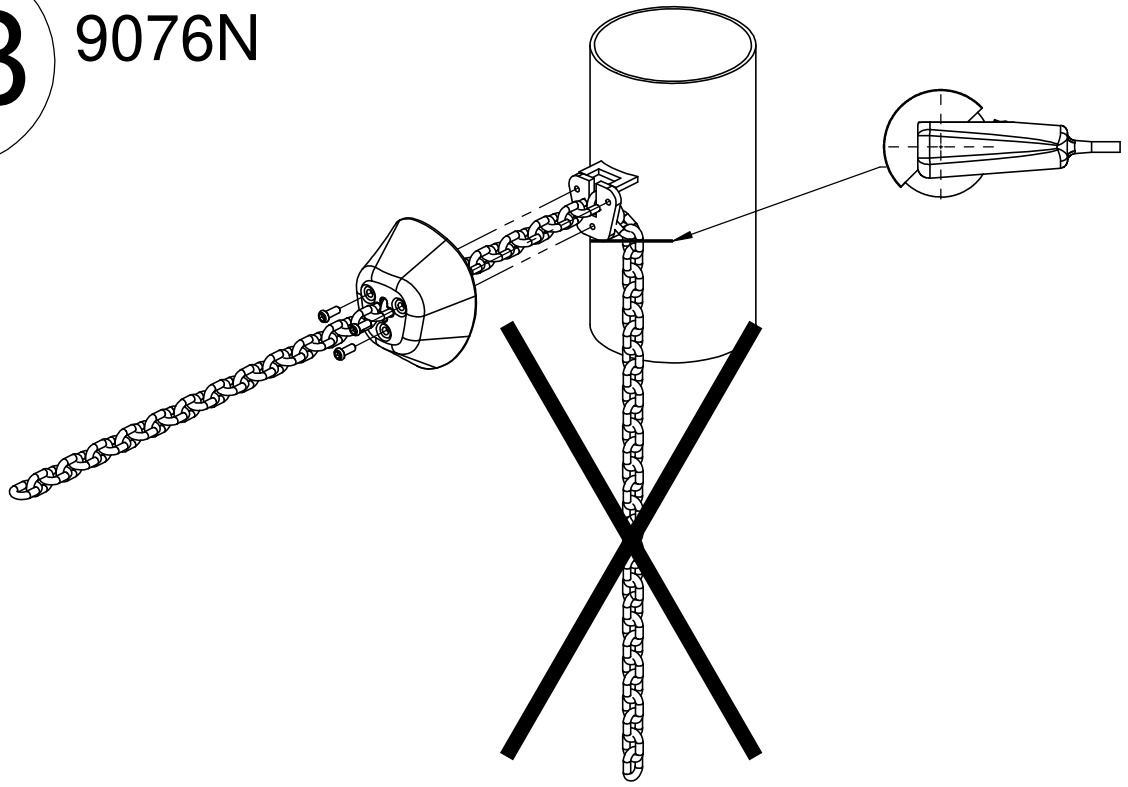

5B

9076N



5C

9076N

Nr	Σ	Element	DIN	ELEMENT
24	3		ISO 7380	M6x16
49	1		-	PRT

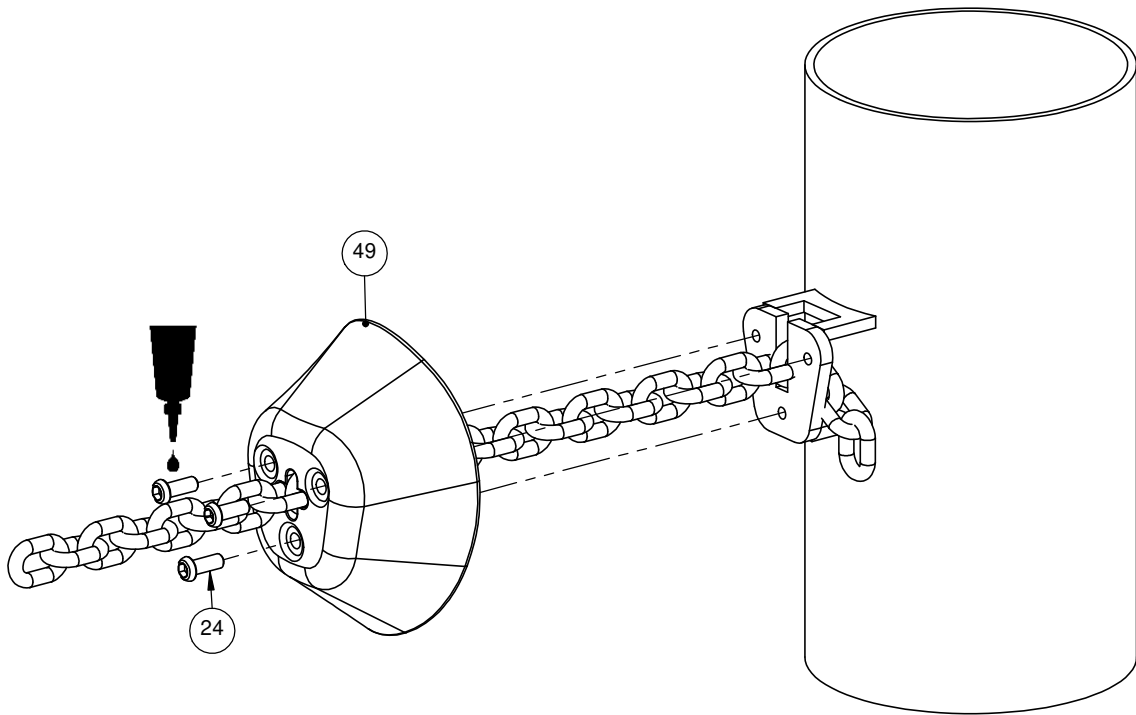

6

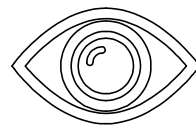

9076N

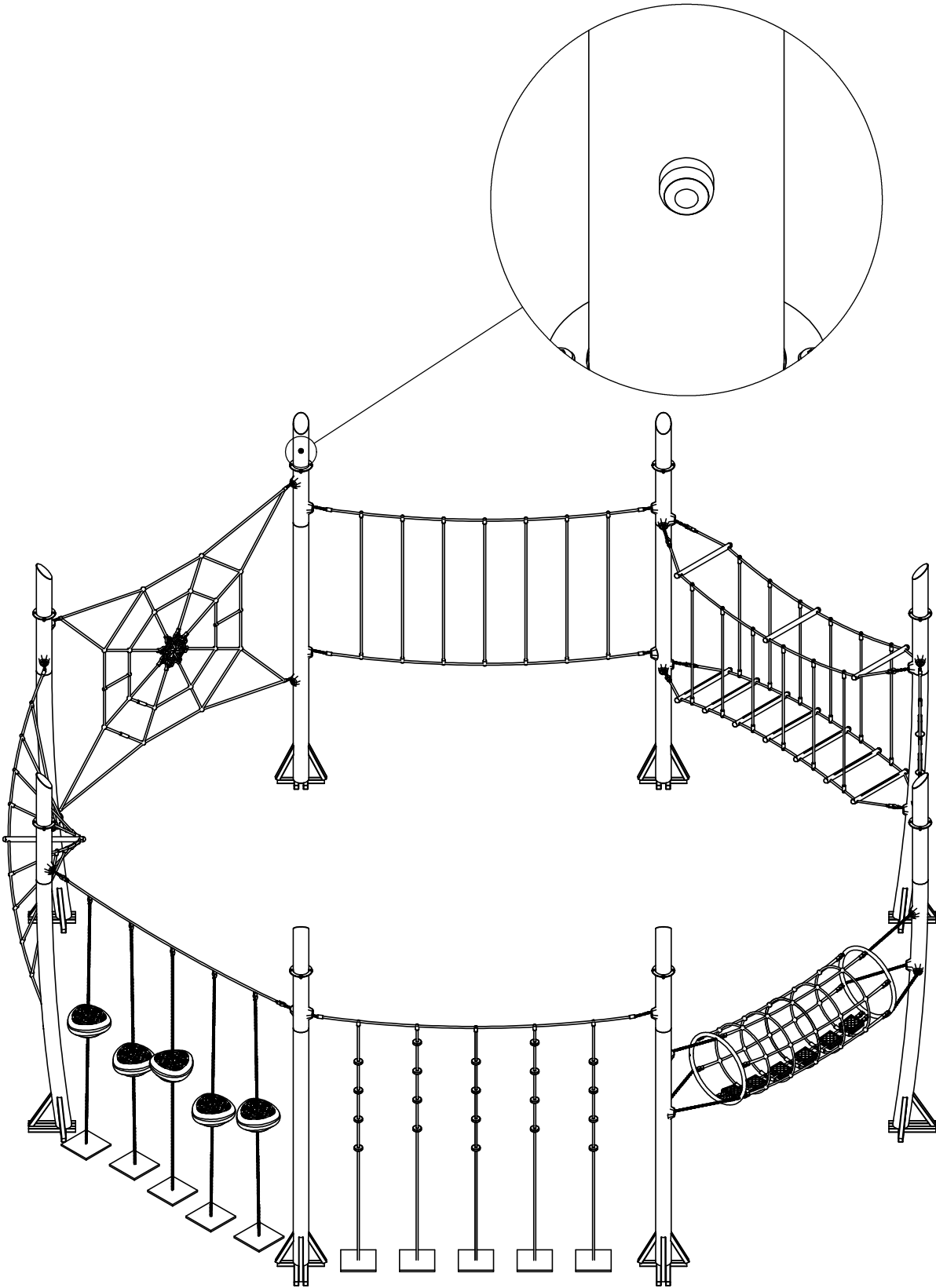

INST_Z_1



INST_Z_1

Nr	Σ	Element		
213	1		-	Z_NA_1
214	1		-	Z_NA_2

